



# The Cloud Networking Solution for Small and Medium Businesses

Hotels | Schools | Offices | Restaurants | and more





# CORPORATE PROFILE

Founded in 1996, TP-Link is a global conglomerate specializing in network communications, consumer electronics, and surveillance. We've grown from humble beginnings to a world leader, consistently ranked as the No. 1 provider of Wi-Fi devices by analyst firm IDC for over a decade.\* Our product range, featuring top brands like TP-Link®, Kasa®, Tapo®, TP-Link Omada®, Aginet™, and VIGI®, connects over 1.7 billion people in more than 170 countries.

We are committed to independent R&D, manufacturing, and marketing, ensuring high-quality, reliable, and high-performance products. Our three R&D centers and four global supply systems, supported by over 40 subsidiaries, underscore our operational excellence and innovative edge.

As we continue to harness cutting-edge technology, our focus remains on making life better with technology, fostering a sustainable and safer society, and bringing innovative solutions to users worldwide. Our guiding principle, 'Reliable,' is embedded in every aspect of our development, reflecting our dedication to enhancing technology's wonders for all.

\*According to the IDC Worldwide Quarterly WLAN Tracker Report, Q4 2022 Final Release

# CONTENTS

<b>Omada Solution's Strengths</b>	<b>04</b>
<b>Omada SDN and Products</b>	<b>06</b>
What is Omada	06
Omada Controllers	07
Omada Wi-Fi 7	12
Omada Access Points	14
Omada Multi-Gigabit Solution	17
Omada Switches	19
Omada Routers	23
Omada Accessories	24
<b>Typical Omada Solutions for Industries and Scenarios</b>	<b>27</b>
Hotels	28
Schools	31
Offices	34
Restaurants	38
PoE Switches for Surveillance	40
Long-Range Networking for Surveillance	44
Wireless Networking for Elevators	46
Business Wi-Fi for Warehouses	48
High-Density Wi-Fi	50
Wi-Fi for Outdoors	52
<b>Product Specifications</b>	<b>54</b>



# Omada Solution's Strengths

TP-Link Omada provides one-stop access to high-quality services and high-performance products for small and medium-sized businesses, integrating complete network devices such as access points, switches, and routers—ideal for use in hotels, schools, restaurants, offices, and more.



## One-Stop Solution with Comprehensive Product Options



### Omada Controllers

- **Cloud-Based Controller**  
Unlimited Scale
- **Software Controllers**  
Unlimited Scale
- **Hardware Controllers**  
From 130 to 1300 Devices



### Omada Access Points

- Ceiling Mount / Wall Plate / Outdoor / Wireless Bridge / High-Density / Gpon
- 10G / 2.5G / GE / FE Ports
- Wi-Fi 7 / 6 / 5 / 4



### Omada L3/L2+ Managed/Smart/Easy Managed Switches

- Core / Aggregation / Access Switches
- 25G / 10G / 2.5G / GE / FE Ports
- PoE++ / PoE+ / PoE



### Omada Routers

- 10G / 2.5G / GE
- Wired / Wireless / 4G+ LTE
- SSL / WireGuard / IPsec VPN / OpenVPN



### Easy Smart & Unmanaged Switches

- 10G / 2.5G / GE / FE
- PoE++ / PoE+ / PoE
- Rackmount / Desktop / Wall-Mounting





### Accessories

- 10G / 1G SFP Modules
- Media Converters
- PoE Adapters
- SFP Cables





Note: Omada Easy Smart switches, Unmanaged switches, and accessories do not support Omada SDN central management.

# Longer Product Warranty and Superb Support

## Superb Pre-Sales Services

-  **Certification and Training**  
Entry-level, associate-level, and professional-level training and certifications are provided.
-  **Tailored Network Deployment Advisor**  
Customized solutions tailored to your unique business needs with professional tools.
-  **Professional Site Surveys**  
The Omada professional support team offers evaluations of your unique networking needs.

## Superb After-Sales Services

-  **Longer Product Warranty (varies between regions/countries)**
-  **Dedicated Omada Support (varies between regions/countries)**  
Get dedicated support from our SMB Hotline, Email, and Live Chat. The Omada support team is always here for you.
-  **Official Omada Community**  
Official community services include timely Q&A and authoritative information supply.
-  **Localization Support Teams**  
Multiple localization teams for readily available support.

## Solid Brand Endorsement

### Vertical Integration

TP-Link operates in-house manufacturing facilities to maintain a high standard and strict cost control of every component, enabling better value than traditional OEM's.

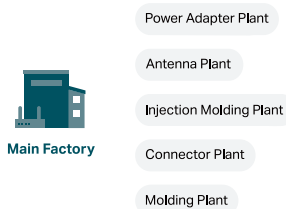

Floor Space: **400,000+** m<sup>2</sup>



### Stable Supply Chain — Localized Production. Global Logistics.

- Comprehensive steady supply chain
- Controls the cycle time and improves production efficiency
- Strict quality management
- Full cost control
- Optimal logistics solution with 90% direct routes
- Local warehouse for sufficient local stocks and fast delivery\*

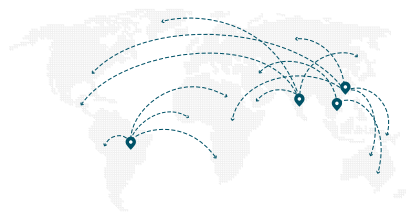

\*Applicable to the US region and may vary between regions/countries.

### World's No. 1 Wi-Fi Product Provider

- World's No. 1 Wi-Fi Product Provider for 12 consecutive years\*
- Strict quality assurance throughout design, development, and manufacturing from start to finish
- Over 20 years of product testing and manufacturing have built our hard-earned reputation for reliability

# No.1

\*Source: IDC Worldwide Quarterly WLAN Tracker, Q4 2022

## Partner Program

<https://partner.tp-link.com/>

The TP-Link SolutionX Partner Program is a simple and effective program tailored for our solution expert partners including installers, system integrators, and MSPs, adding sales, technical, training, and marketing benefits to grow your business. Join the SolutionX Partner Program to engage more with Omada products, receive demo kits, and get rewarded for your sales.

Note: The Partner Program and benefits may vary according to your region. Please contact your local TP-Link representative for more information



- Deal Registration
- Sales Tools
- Knowledge Base
- Marketing Materials
- Promotions
- Support
- Training & Certification

# Omada SDN and Products

## The Cloud Networking Solution for Small and Medium Businesses

TP-Link Omada provides one-stop access to high-quality services and high-performance products for small and medium-sized businesses, integrating complete network devices such as access points, switches, and routers—ideal for use in hotels, schools, restaurants, offices, and more.

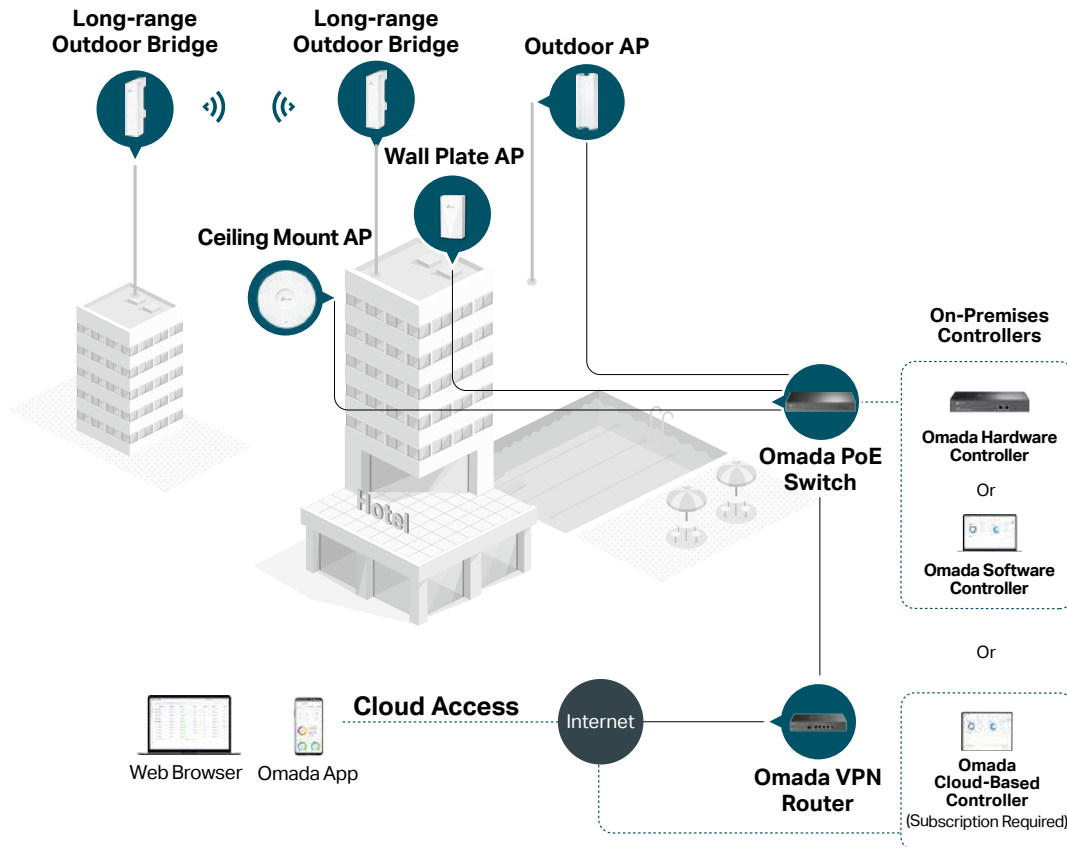

## Software-Defined Networking (SDN)

Omada is an SDN network with a controller as the core to realize automatic deployment of network services and automatic data distribution across routers, switches, and access points.

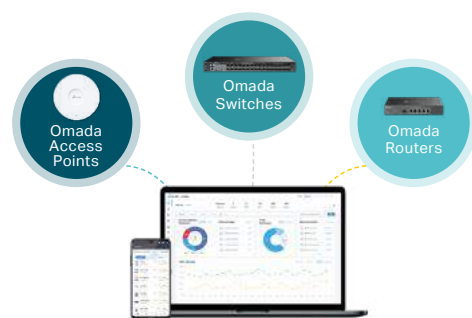

**Omada Centralized Management Platform**  
Controller + Management Interface

- |   |  |   |   |  |
|---|--|---|---|--|
| <br>Centralized Multi-Site<br>Cloud Management | <br>Easy Operation and<br>Maintenance | <br>Always-Assured<br>Security | <br>Higher<br>Reliability | <br>Controllers, APs, Switches,<br>Routers, and Accessories |
| <br>Wi-Fi 7                                    | <br>Wi-Fi 6                           | <br>Full 10G Solution          | <br>25G Ports             | <br>L3 Switches   |

# Omada Controllers

Type	On-Premises Controller (Hybrid Cloud)		Cloud Controller
	Omada Hardware Controller	Omada Software Controller	Omada Cloud-Based Controller
Usage Method	Connect to the intranet	Deploy to intranet servers or private clouds	Pay, log in, and use, with zero-touch provisioning
Management Scale	OC200: ≤ 100 APs + 20 Switches + 10 Routers OC300: ≤ 500 APs + 100 Switches + 100 Routers OC400: ≤ 1000 APs + 200 Switches + 100 Routers	Unlimited (Recommend ≤10,000)*	Unlimited
Network Type	Small/Medium local networks	Medium/Large networks	Medium/Large multi-site networks
Pricing Model	Hardware Costs	Free	Device License Fee
Cloud Access	✓	✓	✓
Automatic Channel Selection	✓	✓	✓
Automatic Transmit Power Adjustment	✓	✓	✓
Zero-Touch Provisioning	-	-	✓
System Management	Multi-Site Management, Multi-User Privilege Assignment, Wi-Fi Heatmap Simulator, Network Summary Report, Abnormal Event Warnings and Notifications, Batch Configuration, Diagnosis Tools		
Device Management	Captive Portal (Voucher, SMS, etc.), Mesh, Seamless Roaming, VPN, Batch Firmware Upgrading		

\*Actual management scale of the Omada Software Controller depends on the PC/server's hardware specifications

## Omada Hardware Controllers



**OC400**

- 2× 10G SFP+ Ports
- 4× 10/100/1000 Mbps Ethernet Ports
- 2× USB 3.0 Ports
- Centralized Management for APs, Switches, and Routers
- Up to 1000 APs + 200 Switches + 100 Routers
- Cloud Access
- Redundant Power Supply

 No PC/Server Needed



**OC300**

- 2× 10/100/1000 Mbps Ethernet Ports
- 1× USB 3.0 Port
- Centralized Management for APs, Switches, and Routers
- Up to 500 APs + 100 Switches + 100 Routers
- Cloud Access

 Reliable and Secure



**OC200**

- 2× 10/100 Mbps Ethernet Ports
- 1× USB 2.0 Port + 1× Micro-USB Port
- Centralized Management for APs, Switches, and Routers
- Up to 100 APs + 20 Switches + 10 Routers
- Cloud Access

 Cloud Access for Remote Management

 Multi-Site Management



## Omada Software Controller

- Centralized Management for APs, Switches, and Routers
- Unlimited Management Scale\*
- Cloud Access
- Real-Time Monitoring
- Easy-to-Use Dashboard



## Omada Cloud-Based Controller

- Centralized Cloud Management\*\*
- Unlimited Management Scale\*\*\*
- Exists Entirely in the Cloud
- Zero-Touch Provisioning
- No Additional Hardware Controller Investment
- No On-Premises Installation

Note: Please refer to page 54 for detailed product specifications.

\*Actual management scale of the Omada Software Controller depends on the PC/server's hardware specifications.

\*\*Not all Omada SDN products are supported by the Omada Cloud-Based Controller. Please go to [www.tp-link.com/omada-cloud-based-controller/product-list](http://www.tp-link.com/omada-cloud-based-controller/product-list) to confirm which models are compatible with the Omada Cloud-Based Controller.

\*\*\*The management scale of the Omada Cloud-Based Controller may depend on the quantity of purchased device licenses.

# Omada Liberates SIs and Administrators

## Simple Management

### Full Network Device Management

The Omada SDN solution provides a network with a controller as the core—all controlled from a single interface anywhere, anytime.

Note: Omada Easy Smart switches, Unmanaged switches, and accessories do not support Omada SDN central management.



### Real-Time Network Status and Full Report of Clients, Devices, WAN, and Wi-Fi

SIs can easily share network service quality with administrators through customized reports.



### Easy and Intelligent Network Monitoring

The easy-to-use dashboard ensures SIs follow real-time network status and various kinds of information at a glance.

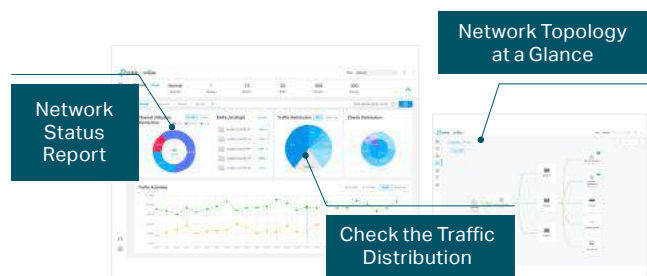

### Managed Service Provider (MSP) Mode

Managed Service Provider mode sets up multi-customer and multi-site according to the expanding management scope.

### Multi-Tenant Privilege Assignment

Take advantage of multi-person management and multi-level permissions, while adding administrators wherever necessary.

**Multi-Customer & Multi-Account Management**

Manage multiple customers without switching controllers. Liberate SI partners.

&

**Multi-Site Management**

Easier to check and manage multiple sites with a more well-organized management structure. A 4-layer management system is provided.

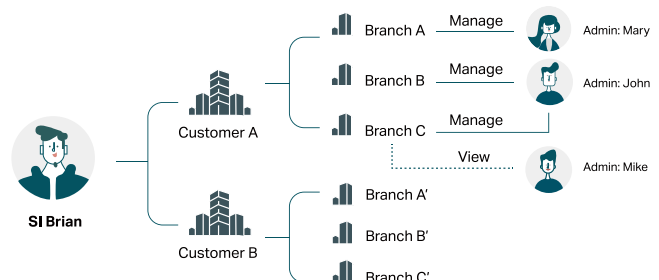

### MAP

- **Site MAP:** Supports adding Site geographic markup and retrieving Site location, while visually displaying the site network status.
- **Device MAP:** Supports adding Device geotags and retrieving Device locations.

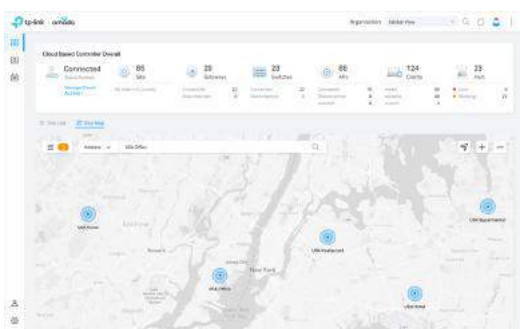

### OpenAPI

Facilitates integrated access and system integration with clients' existing systems

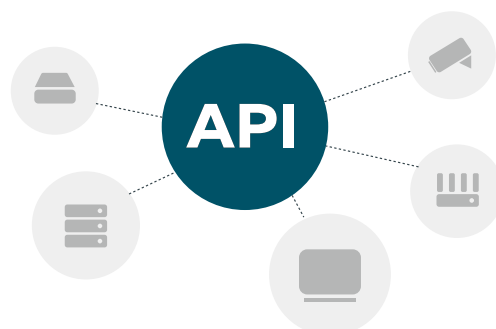



## Easy Operation and Maintenance

### Zero-Touch Provisioning\*

Allows admins to remotely deploy and configure multi-site networks, so there's no need to send out an engineer for on-site configuration.

\*Zero-Touch Provisioning requires the use of the Omada Cloud-Based Controller.

**SI in Office.** NO NEED to send out an engineer to the customer site.

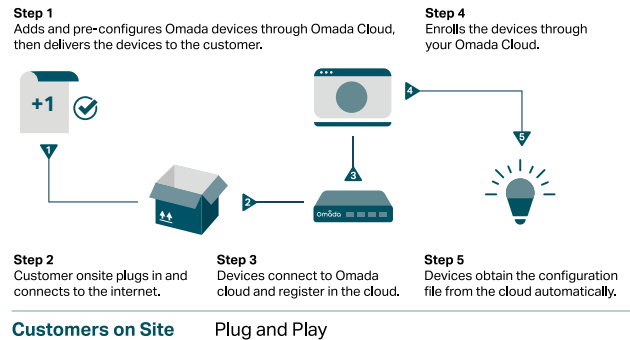

### Channel Selection and Power Adjustment Optimization

Provides powerful wireless performance while greatly reducing Wi-Fi interference by automatically adjusting the channel settings and transmission power levels of neighboring APs in the same network.

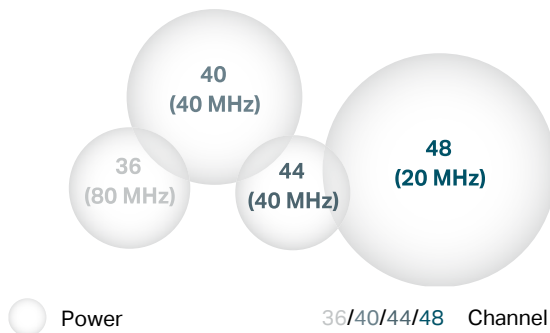

### Batch Configuration

Batch configuration of devices and remote firmware updates greatly liberate SIs.



### Wi-Fi Heatmap Simulator to Generate Wi-Fi Solutions With Ease

Simulates the wireless coverage effect of APs in the actual site and determines the appropriate number and location of APs according to the coverage requirements.

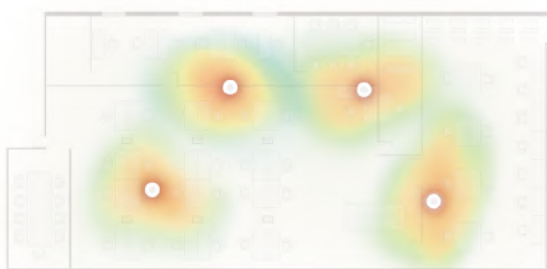

Unreasonable AP Deployment without Wi-Fi Heatmap Simulator

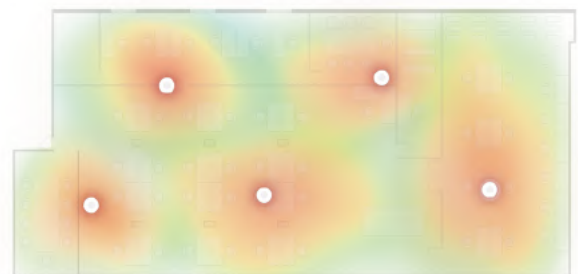

Reasonable AP Deployment with Wi-Fi Heatmap Simulator

### Configuration Synchronization

Make sure you know what's happening on your network at all times. Observe the results and status of device configuration in real time.

### Integrated Troubleshooting Tools

PING | Traceroute | DNS QUERY | Terminal | Packet Capture

# Omada Always Optimizes User Experience

## Always-Assured Security

### IDS (Intrusion Detection System) / IPS (Intrusion Prevention System)

The integrated IDS/IPS engine bolsters threat detection and defense. Additionally, there is an embedded, regularly updated signature database for attack prevention.



### DPI (Deep Packet Inspection)

Using a built-in database, DPI distinguishes between different applications, like financing, P2P downloading, and video conferencing. This helps Ops better understand the intent of every IP packet and reduce overall costs by prioritizing traffic more intelligently.



## Abundant Security Functions

Powerful firewall and advanced security functions further protect the network and data.



High-Security VPN



Powerful Firewall



URL/IP/MAC Filtering



Access Control



Advanced WPA3 Encryption



Captive Portal



PPSK

## Higher Reliability

Cloud services are guaranteed with 99.9% SLA availability, 24/7 automated fault detection, geographically isolated back-up servers, and reliable product quality. Your network functions even if management traffic is interrupted.

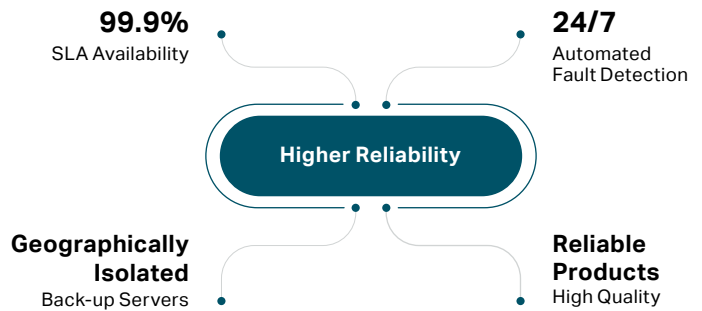

## More Options with Omada App Centralized Management Mode — A Free and Lightweight AP Solution

The Omada app provides a free and lightweight centralized management solution for access points, ideal for small-scale Wi-Fi networking.



No Additional Expense



Cloud Management



Batch Configuration



Networking Tools



Quick Wi-Fi Setup



Multi-Network Management



# Wi-Fi 7

Break Through Boundaries



Up to  
46 Gbps



6 GHz



Up to  
320 MHz



4K-QAM



16×16  
MU-MIMO



MLO



Multi-RU



Preamble  
Puncturing



## What is Wi-Fi 7?

Wi-Fi 7 is the upcoming Wi-Fi standard, also known as IEEE 802.11be Extremely High Throughput (EHT). It works across all three bands (2.4 GHz, 5 GHz, and 6 GHz) to fully utilize spectrum resources. While Wi-Fi 6 was built in response to the growing number of devices in the world, Wi-Fi 7's goal is to deliver astounding speeds for every device with greater efficiency. If you're struggling with constant buffering, lag, or congestion, a Wi-Fi 7 router may be your best solution.

Wi-Fi 7 introduces 320 MHz ultra-wide bandwidth, 4096-QAM, Multi-RU, and Multi-Link Operation to provide speeds 4.8× faster than Wi-Fi 6 and 13× faster than Wi-Fi 5. Unlock more scenarios than ever before.

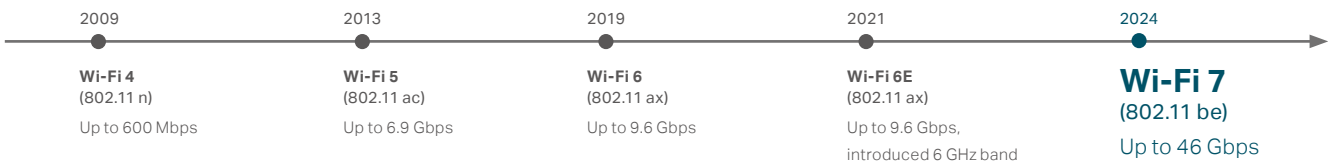

## What Does Wi-Fi 7 Bring?

With the upcoming 7th generation of Wi-Fi, the ultimate online experience will be unleashed.



### 4.8× Faster

Wi-Fi 7 accelerates throughput up to 46 Gbps.



### 100× Lower Latency\*

Worst Case Latency is 100× better compared to Wi-Fi 6 with 15× better AR/VR performance.



### 5× Network Capacity\*

With 320 MHz and MLO (Multi-Link Operation), Wi-Fi 7 provides up to 5× greater capacity than Wi-Fi 6.

\*Data is from semiconductor companies. Maximum wireless signal rates are the physical rates derived from IEEE Standard 802.11 specifications. Actual wireless data throughput and wireless coverage are not guaranteed and will vary as a result of network conditions, client limitations, and environmental factors, including building materials, obstacles, volume and density of traffic, and client location.

## The Wide and Clear 6 GHz Band

Unlike the 2.4 GHz and 5 GHz bands that are filled with signals from microwave ovens, radios, phones, radar, satellite equipment, and Bluetooth, the 6 GHz band brings cleaner and wider band resources to Wi-Fi.

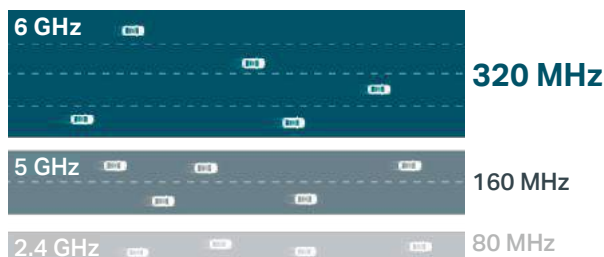
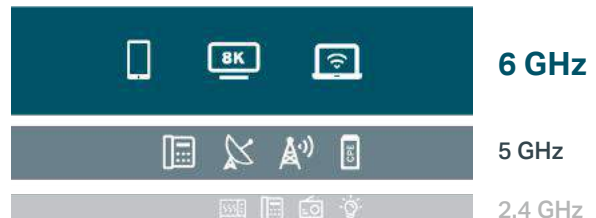

## Up to 320 MHz Bandwidth Brings the Ultimate Speed

The 6 GHz band brings cleaner and wider band resources to Wi-Fi, and the Wi-Fi 7 protocol standard adds a 320 MHz bandwidth mode for 6 GHz, doubling Wi-Fi 6 throughput. Now your 8K devices can cruise at phenomenal speeds without any other devices impeding them.



## Multi-Link Operation (MLO) Increases Throughput, Reduces Latency, and Improves Reliability

Simultaneously send and receive data over multiple radio bands to create a single aggregated connection. This will not only provide faster throughput performance but will also help reduce latency and allow data to flow unimpeded by network traffic or interference.

### Wi-Fi 6

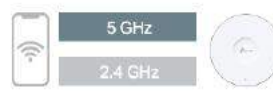

### Wi-Fi 7

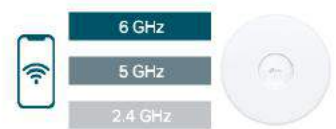

## Multi-RU for Higher Spectrum Efficiency

Increases data transfer efficiency by introducing a more flexible way for Resource Unit (RU) allocation. Wi-Fi 7 allows multiple RUs to be assigned to a single user and combines RUs for increased transmission efficiency.

### Wi-Fi 6

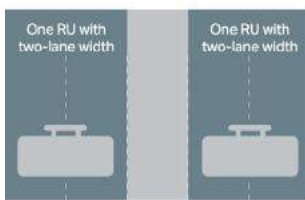

One lane width is wasted

### Wi-Fi 7

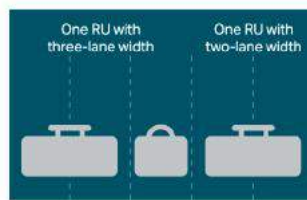

No lane width is wasted

## Preamble Puncturing for Stronger Anti-Jamming

Preamble Puncturing technology prevents interference on a portion of a channel from rendering the rest of the channel unusable.

### Without Preamble Puncturing



### With Preamble Puncturing



## Connect More Devices with 16x16 MU-MIMO

16 streams are available, double the theoretical physical transmission rate compared to Wi-Fi 6. This allows connections to more devices simultaneously, increasing overall throughput and peak performance.



## Pack More Data with 4K-QAM

4096-QAM improves raw speeds by 20% compared to Wi-Fi 6's 1024-QAM. This enables flawless 4K/8K videos and massive online gaming without lag.

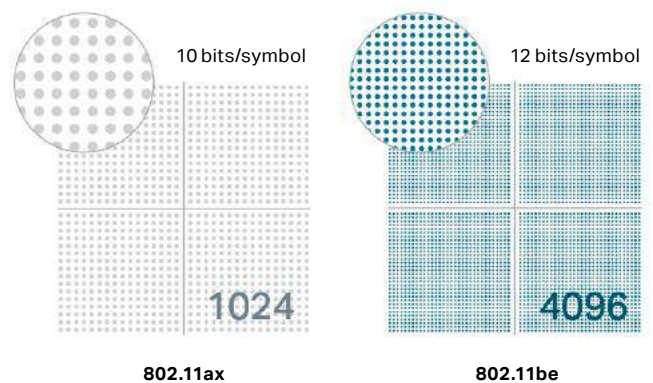

## Backward Compatible with Wi-Fi 6 and Wi-Fi 6E Features



### OFDMA for Increased Efficiency

Deliver multiple parcels of data to multiple devices simultaneously. This vast improvement in efficiency works for both uploads and downloads.



### BSS Coloring for Anti-Jamming

Minimize Wi-Fi conflicts with your neighbor by marking frames from neighboring networks so that your router can ignore them.



### Target Wake Time

Schedules transmissions and allows a power-saving 20 MHz stream to coexist with a high-speed 160 MHz stream, improving battery life for mobile and IoT devices.

# Break Through the Boundaries of Your Business

BE22000 Ceiling Mount Tri-Band Wi-Fi 7 Access Point

## EAP783

- 6 GHz Tri-Band Wi-Fi 7 Speeds up to 22 Gbps\*
- Two 10G PoE Ports
- Omada Mesh and Seamless Roaming
- Bluetooth
- Centralized Management



### EAP783

BE22000 Ceiling Mount Tri-Band Wi-Fi 7 Access Point

- BE22000 Tri-Band Wi-Fi 7**  
11520 Mbps (6 GHz) + 8640 Mbps (5 GHz) + 1376 Mbps (2.4 GHz)\*
- Clear 6 GHz Band**  
Brings Cleaner and Wider Band Resources to Wi-Fi.
- 2x 10G Ports**  
Unlock the Full Potential of Wi-Fi 7
- Advanced Wi-Fi Functions**  
Multi-Link Aggregation, Mesh, and Seamless Roaming



### EAP773

BE11000 Ceiling Mount Tri-Band Wi-Fi 7 Access Point

- BE11000 Tri-Band Wi-Fi 7**  
5760 Mbps (6 GHz) + 4320 Mbps (5 GHz) + 574 Mbps (2.4 GHz)\*
- Clear 6 GHz Band**  
Brings Cleaner and Wider Band Resources to Wi-Fi.
- 1x 10G Port**  
Unlock the Full Potential of Wi-Fi 7
- Advanced Wi-Fi Functions**  
Multi-Link Aggregation, Mesh, and Seamless Roaming
- Ultra-thin Design**  
The Ultimate Slim  $\phi 220 \times 32$  mm Casing

## High-density Connectivity

Improves capacity in high-density environments to connect up to 640 clients (EAP783). Leverage multi-user capabilities and upgrade your business like never before.

## Seamless Roaming for Uninterrupted Streaming

802.11k, 802.11v, and 802.11r seamless roaming ensure customers enjoy uninterrupted streaming when moving around by switching clients automatically to the access points with the optimal signal.

## Omada Mesh for Flexible Deployment























Enables wireless connectivity between APs for extended range without additional cables, making outdoor wireless deployments more flexible and convenient. Intelligent self-organization and self-healing ensure you stay online even when one AP is disrupted.

## Guest Network with Captive Portal















Provides secure Wi-Fi access along with multiple authentication options (SMS/Voucher, etc.) and abundant wireless security features.

Note: Due to regulatory limits on spectrum, the 5 GHz band of the EU version product cannot have 240 MHz bandwidth, hence the theoretical speeds of the EU version in the 5 GHz band is ~67% of the corresponding US version.

# Omada Access Points

	Wi-Fi 7		Wi-Fi 6					
	BE22000	BE11000	AX6000	AX5400	AX3600	AX3000	AX1800	
Ceiling Mount Access Points	 <p><b>EAP783</b></p> <ul style="list-style-type: none"> <li>•Wi-Fi 7 Tri-Band</li> <li>•802.3bt PoE</li> <li>•2x 10G Ports</li> <li>•Bluetooth</li> <li>•(Adapter Not Included)</li> </ul>	 <p><b>EAP773</b></p> <ul style="list-style-type: none"> <li>•Wi-Fi 7 Tri-Band</li> <li>•802.3at/bt PoE</li> <li>•1x 10G Port</li> <li>•Bluetooth</li> <li>•(Adapter Not Included)</li> </ul>	 <p><b>EAP683 UR</b></p> <ul style="list-style-type: none"> <li>•Long-Range Coverage</li> <li>•802.3at PoE</li> <li>•1x 2.5G Port</li> <li>•Mesh</li> <li>•Roaming</li> <li>•Bluetooth</li> <li>•(Adapter Not Included)</li> </ul>  <p><b>EAP680</b></p> <ul style="list-style-type: none"> <li>•802.3at PoE</li> <li>•1x 2.5G Port</li> <li>•Mesh</li> <li>•Roaming</li> <li>•Bluetooth</li> </ul>	 <p><b>EAP670</b></p> <ul style="list-style-type: none"> <li>•802.3at PoE</li> <li>•1x 2.5G Port</li> <li>•Bluetooth*</li> <li>•Mesh</li> <li>•Roaming</li> </ul>  <p><b>EAP673</b></p> <ul style="list-style-type: none"> <li>•Same as EAP670, Except Adapter Not Included</li> </ul>	 <p><b>EAP660 HD</b></p> <ul style="list-style-type: none"> <li>•802.3at PoE</li> <li>•1x 2.5G Port</li> <li>•Bluetooth*</li> <li>•Mesh</li> <li>•Roaming</li> </ul>	 <p><b>EAP650</b></p> <ul style="list-style-type: none"> <li>•802.3at and Passive PoE</li> <li>•1x 1G Port</li> <li>•Mesh</li> <li>•Roaming</li> </ul>  <p><b>EAP653</b></p> <p><b>(1-pack, 5-pack)</b></p> <ul style="list-style-type: none"> <li>•Same as EAP650, Except Adapter Not Included</li> </ul>  <p><b>EAP653 UR</b></p> <ul style="list-style-type: none"> <li>•Long-Range Coverage</li> <li>•802.3at and Passive PoE</li> <li>•1x 1G Port</li> <li>•Mesh &amp; Roaming</li> <li>•Bluetooth</li> <li>•(Adapter Not Included)</li> </ul>	 <p><b>EAP620 HD</b></p> <ul style="list-style-type: none"> <li>•802.3at and Passive PoE</li> <li>•1x 1G Port</li> <li>•Mesh</li> <li>•Roaming</li> </ul>	 <p><b>EAP610</b></p> <ul style="list-style-type: none"> <li>•802.3at and Passive PoE</li> <li>•1x 1G Port</li> <li>•Mesh</li> <li>•Roaming</li> </ul>  <p><b>EAP613</b></p> <p><b>(1-pack, 5-pack)</b></p> <ul style="list-style-type: none"> <li>•Same as EAP610, Except Adapter Not Included</li> </ul>
Wall Plate Access Points				 <p><b>EAP673-Extender</b></p> <ul style="list-style-type: none"> <li>•1x 1G Port</li> <li>•AC Plug Power Supply</li> <li>•Mesh</li> </ul>		 <p><b>EAP655-Wall</b></p> <ul style="list-style-type: none"> <li>•802.3af/at PoE</li> <li>•4x 1G Ports</li> <li>•PoE Pass-through</li> </ul>  <p><b>EAP650-Wall</b></p> <ul style="list-style-type: none"> <li>•802.3af PoE</li> <li>•2x 1G Ports</li> </ul>	 <p><b>EAP615-Wall</b></p> <ul style="list-style-type: none"> <li>•802.3af/at PoE</li> <li>•4x 1G Ports</li> <li>•PoE pass-through</li> </ul>	
Outdoor Access Points						 <p><b>EAP650-Outdoor</b></p> <ul style="list-style-type: none"> <li>•802.3at and Passive PoE</li> <li>•Smart Antennas</li> <li>•1x 1G Port</li> <li>•Mesh</li> <li>•Seamless Roaming</li> <li>•IP67</li> </ul>	 <p><b>EAP625-Outdoor HD</b></p> <ul style="list-style-type: none"> <li>•802.3at and Passive PoE</li> <li>•1x 1G Port</li> <li>•Mesh</li> <li>•Seamless Roaming</li> <li>•IP67</li> <li>•Bluetooth</li> <li>•Outdoor Antennas</li> </ul>  <p><b>EAP623-Outdoor HD</b></p> <ul style="list-style-type: none"> <li>•802.3at and Passive PoE</li> <li>•1x 1G Port</li> <li>•Mesh</li> <li>•Seamless Roaming</li> <li>•IP67</li> <li>•Smart Antennas</li> </ul>	 <p><b>EAP610-Outdoor</b></p> <ul style="list-style-type: none"> <li>•802.3at and Passive PoE</li> <li>•1x 1G Port</li> <li>•Mesh</li> <li>•Seamless Roaming</li> <li>•IP67</li> </ul>
Desktop Access Points						 <p><b>EAP650-Desktop</b></p> <ul style="list-style-type: none"> <li>•802.3af/at PoE and DC Power Supply</li> <li>•4x 1G RJ45 Ports</li> <li>•1x RJ11 Port</li> <li>•PoE Pass-through</li> </ul>		

\*V2 of EAP670 and EAP660 HD supports Bluetooth while V1 doesn't.

	Wi-Fi 5				Wi-Fi 4
	AC1750	AC1350	AC1200	AC867	N300
Ceiling Mount Access Points	 <p><b>EAP265 HD/ EAP245 (1-pack, 5-pack)</b></p> <ul style="list-style-type: none"> <li>•802.3af and Passive PoE</li> <li>•2× 1G Ports</li> <li>•Mesh</li> <li>•Roaming</li> </ul>	 <p><b>EAP225</b></p> <ul style="list-style-type: none"> <li>•802.3af and Passive PoE</li> <li>•1× 1G Port</li> <li>•Mesh</li> <li>•Roaming</li> </ul>  <p><b>EAP223</b></p> <ul style="list-style-type: none"> <li>•Same as EAP225, Except Adapter Not Included</li> </ul>			 <p><b>EAP115</b></p> <ul style="list-style-type: none"> <li>•802.3af PoE and 9 VDC</li> </ul>  <p><b>EAP110</b></p> <ul style="list-style-type: none"> <li>•Passive PoE</li> </ul>
Wall Plate Access Points			 <p><b>EAP235-Wall</b></p> <ul style="list-style-type: none"> <li>•802.3af/at PoE</li> <li>•4× 1G Ports</li> <li>•PoE Pass-through</li> </ul>  <p><b>EAP230-Wall</b></p> <ul style="list-style-type: none"> <li>•802.3af PoE</li> <li>•2× 1G Ports</li> </ul>		 <p><b>EAP115-Wall</b></p> <ul style="list-style-type: none"> <li>•802.3af PoE</li> <li>•2× 10/100 Mbps Ports</li> </ul>
Outdoor Access Points			 <p><b>EAP225-Outdoor</b></p> <ul style="list-style-type: none"> <li>•802.3af and Passive PoE</li> <li>•1× 1G Port</li> <li>•Mesh</li> <li>•Seamless Roaming</li> <li>•IP65</li> </ul>		 <p><b>EAP113-Outdoor</b></p> <ul style="list-style-type: none"> <li>•802.3af and Passive PoE</li> <li>•IP65</li> </ul>  <p><b>EAP110-Outdoor</b></p> <ul style="list-style-type: none"> <li>•Passive PoE</li> <li>•IP65</li> </ul>
Outdoor Bridges				 <p><b>EAP215-Bridge KIT</b></p> <ul style="list-style-type: none"> <li>•5 km+ Transmission</li> <li>•Passive PoE and 12 VDC</li> <li>•IP65</li> </ul>  <p><b>EAP211-Bridge KIT</b></p> <ul style="list-style-type: none"> <li>•1 km+ Transmission</li> <li>•Passive PoE and 12 VDC</li> <li>•IP65</li> </ul>	 <p><b>EAP115-Bridge KIT</b></p> <ul style="list-style-type: none"> <li>•5 km+ Transmission</li> <li>•Passive PoE and 12 VDC</li> <li>•IP65</li> </ul>

## Omada GPON Access Points



- AX1800
- DC Power Supply
- 1× GPON
- 4× GE RJ45 Ports
- 1× FXS RJ11 Port
- Seamless Roaming
- Supports 802.3af PoE Out

**EAP610GP-Desktop**



- AX1800
- AC Power Supply
- 1× GPON
- 2× GE RJ45 Ports
- 1× FXS RJ11 Port
- Seamless Roaming

**EAP615GP-Wall**



# Future-Proof Multi-Gigabit Network Solution

Omada 10GbE Routers, 25GbE & 10GbE & 2.5GbE Switches and Business Wi-Fi Solution



Omada offers routers, switches, access points with 25GbE, 10GbE, and 2.5GbE ports. These products combine to form a powerful multi-gigabit network solution, unlocking the full potential of your bandwidth and devices. Integrating the Omada Software-Defined Networking (SDN) system and its centralized management capability makes it far more efficient to control your whole business network.

## Full Lightning-Fast 25G/10G/2.5G Connections



## Unleash the Real Wi-Fi 7/6 with 10GbE or 2.5GbE PoE Ports

Omada Wi-Fi 7/6 access points provide blazing-fast business Wi-Fi. 10GbE and 2.5GbE ports match the full bandwidth potential of Wi-Fi 7/6 speeds.

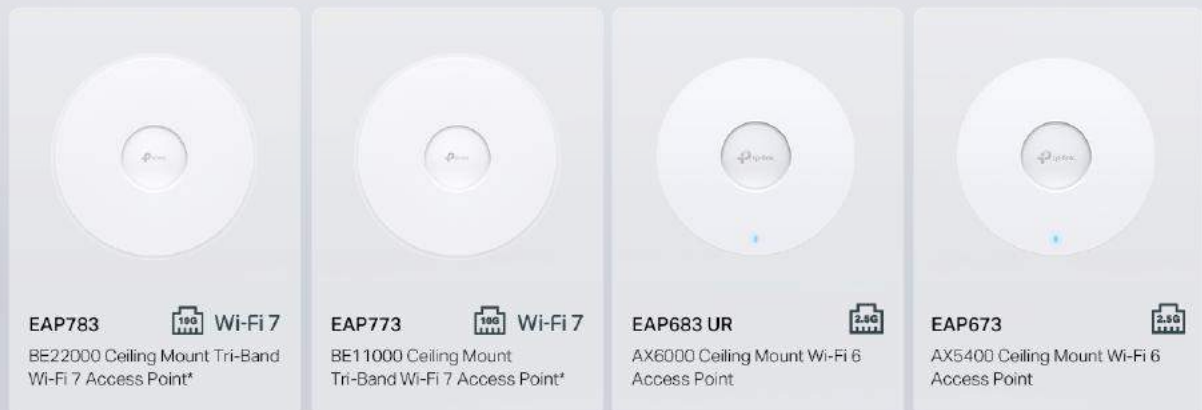

\*Due to regulatory limits on spectrum, the 5 GHz band of the Wi-Fi 7 access point EU version cannot have 240 MHz bandwidth, hence the theoretical speeds of the EU version in the 5 GHz band is ~67% of the corresponding US version.

# 25G/10G/2.5G Multi-Gigabit Managed Switches

Omada's 25G/10G/2.5G multi-gigabit managed switches are equipped with 25 Gbps fiber, 10 Gbps fiber, 10 Gbps copper, or 2.5 Gbps copper ports. This flexibility provides maximum performance and low latency. Easily establish reliable and lightning-fast connections to Wi-Fi 7/6 access points, storage servers, and other switches and devices.

10GbE PoE++ Port  
Up to 60 W PoE Budget  
for Every Port



## Find the Best 25G/10G/2.5G Multi-Gigabit Managed Switch for You

Managed switches with 25G fiber, 10G fiber, 10G copper, or 2.5 Gbps copper are available to fit many deployment scenarios. They provide high performance, scalability, and cost-effectiveness that business customers need from their multi-gigabit networking solutions.

10G Fiber with 25G Fiber Uplink	Full 10G Fiber	10G Copper with 10G Fiber Uplink	2.5G Copper with 10G Fiber Uplink	Gigabit Fiber or Copper with 10G Fiber Uplink
<ul style="list-style-type: none"> <li>• 26x 10G SFP+ &amp; 6x 25G SFP28 Slots</li> <li>• L3 Features</li> <li>• Stacking, OSPF, VRRP, ERPS, and Redundant Power Supply</li> <li>• Built for the Core Layer</li> </ul>	<ul style="list-style-type: none"> <li>• Up to 32/16/8x 10G SFP+ Ports</li> <li>• L2+ Features</li> <li>• Built for the Aggregation Layers</li> </ul>	<ul style="list-style-type: none"> <li>• 4x 10GbE PoE++ and 2x 10G SFP+ Ports</li> <li>• 802.3af/at/bt PoE++ with 200 W PoE Budget</li> <li>• L2+ Features</li> <li>• Designed for Connecting Wi-Fi 7/6 Access Points with 10G Ports, 10G NAS, and More.</li> </ul>	<ul style="list-style-type: none"> <li>• 8/16/24x 2.5G Ports</li> <li>• 2/4x 10G SFP+ Uplink Ports</li> <li>• 802.3af/at/bt PoE Output</li> <li>• L2+ Features</li> <li>• Built for Connecting Wi-Fi 7/6 Access Points with 2.5G Ports, 2.5G NAS, and More.</li> </ul>	<ul style="list-style-type: none"> <li>• Up to 48/24x Gigabit + 10G SFP+ Ports</li> <li>• Optional PoE+ and Non-PoE Switches</li> <li>• L2+ Features</li> <li>• Designed for Connecting Access Points, IP Cameras, IP Phones, Wired Devices, and More.</li> </ul>

## Enterprise 10G Gateway Ensures Fast Connectivity

The Omada VPN router with 10G ports supports high-bandwidth aggregation connectivity. Featuring two 10G SFP+ ports (1 WAN, 1 WAN/LAN), it is ideal for enterprise-level businesses, schools, hotels, and large-scale deployments.



# Omada Stackable L3 Managed Switches

End-to-End High-Performance Enterprise-Level Switches



## High-Speed and Flexible Connectivity

The core switches are equipped with 25G QSFP28 ports and provide up to 820 Gbps switching capacity per unit. The aggregation switches and access switches provide 10G uplink and 24 or 48 gigabit ports, creating flexible options to match your business needs.

## Highly Available

Redundant power supplies and fans make it an ideal choice for reliable networking architecture. ERPS supports rapid protection and recovery in a ring topology.

## Enhanced Security Functions

Defend against a range of network threats with ACL support (IPv4 & IPv6), Dynamic ARP Inspection, IEEE 802.1X, MAB, Port Security, and Secure Shell.

## High PoE Capability

Provides the 802.3at PoE+ standard to power network devices with a PoE budget up to 1440 W. Stack power enables power resiliency with higher PoE power budgets.\*

## Abundant Layer 3 Capabilities

Comes with abundant Layer 3 routing protocols that support a scalable network. Static Routing, RIP, OSPF, ECMP, VRRP, DHCP Server, and DHCP Relay are supported. PIM-DM multicast routing protocol guarantees efficient routing for multicast groups.

## Powerful Stacking

Up to 4 units of physical stacking empower the networking structure with built-in redundancy and performance.

\*The PoE budgets of SG6428XHP and SG6654XHP vary with the power supply modules.

# Omada L3/L2+ Managed, Smart, and Easy Managed Switches

Ports	L3 Managed		Aggregation L2+ Managed		Access L2+ Managed			Access Smart			Easy Managed	
	10 Gbps with 25G Uplink	1 Gbps with 10G Uplink	10 Gbps	1 Gbps with 10G Uplink	10 / 2.5 Gbps with 10G Uplink	1 Gbps with 10G Uplink	1 Gbps	2.5 Gbps with 10G Uplink	1 Gbps	10/100 Mbps with 1G Uplink	1 Gbps	
Non-PoE	5										<b>ES205G</b> 5x GE	
	8/10		<b>SX3008F</b> 8x 10G SFP+		<b>SG3210X-M2</b> 8x 2.5G, 2x 10G SFP+		<b>SG3210</b> 8x GE, 2x 1G SFP		<b>SG2008</b> 8x GE (including 1x PD Port)			
	16/18		<b>SX3016F</b> 16x 10G SFP+, RPS						<b>SG2218</b> 16x GE, 2x 1G SFP			
	28/32	<b>SX6632YF</b> 28x 10G SFP+ & 6x 25G SFP28, Stacking, RPS	<b>SG6428X</b> 24x GE + 4x 10G SFP+ Ports, Stacking, RPS	<b>SX3032F</b> 32x 10G SFP+ Ports, RPS	<b>SG3428XF</b> 20x 1G SFP, 4x 1G SFP/ RJ45 Combo, 4x 10G SFP+, RPS	<b>SG3428X-M2</b> 24x 2.5G, 4x 10G SFP+	<b>SG3428X</b> 24x GE, 4x 10G SFP+	<b>SG3428</b> 24x GE, 4x 1G SFP				
	52/54		<b>SG6654X</b> 48x GE + 6x 10G SFP+, Stacking, RPS				<b>SG3452X</b> 48x GE, 4x 10G SFP+	<b>SG3452</b> 48x GE, 4x 1G SFP				
PoE	5/6				<b>SX3206HPP</b> 4x 10GE PoE+, 2x 10G SFP+, 200W PoE Budget				<b>SG2005P-PD</b> 1-Port PoE++ GE in, 4-Port PoE+ GE out, Max 64W PoE Budget, IP55 Weatherproof for Outdoors		<b>ES205GP</b> 5x GE (4x PoE+), 63W PoE Budget (TBD)	
	8/10				<b>SG3210XHP-M2</b> 8x 2.5GE PoE+, 2x 10G SFP+, 240W PoE Budget			<b>SG2210XMP-M2</b> 8x 2.5GE PoE+, 2x 10G SFP+, 160W PoE Budget	<b>SG2210MP</b> 8x GE PoE+, 2x 1G SFP, 150W PoE Budget <b>SG2210P</b> 8x GE PoE+, 2x 1G SFP, 61W PoE Budget <b>SG2008P</b> 4x GE PoE+, 4x GE Non-PoE, 62W PoE Budget		<b>ES210GP</b> 9x GE (8x PoE+), 1x RJ45/SFP GE Combo, 120W PoE Budget (TBD)	
	16/18				<b>SG3218XP-M2</b> 8x 2.5G PoE+, 8x 2.5G Non-PoE, 2x 10G SFP+, 240W PoE Budget				<b>SG2218P</b> 16x GE PoE+, 2x 1G SFP, 150W PoE Budget <b>SG2016P</b> 8x GE PoE+, 8x GE Non-PoE, 120W PoE Budget			
	28		<b>SG6428XHP</b> 24x GE PoE+, 4x 10G SFP+, up to 720W PoE Budget*, Stacking, RPS		<b>SG3428XPP-M2</b> 8x 2.5GE PoE+, 16x 2.5GE PoE+, 4x 10G SFP+, 500W PoE Budget	<b>SG3428XMPP</b> 8x GE PoE+, 16x PoE+, 4x 10G SFP+, 500W PoE Budget	<b>SG3428MP</b> 24x GE PoE+, 4x 1G SFP, 384W PoE Budget		<b>SG2428P</b> 24x GE PoE+, 4x 1G SFP, 250W PoE Budget <b>SG2428LP</b> 16x GE PoE+, 8x GE Non-PoE, 4x 1G SFP, 150W PoE Budget	<b>SL2428P</b> 24x FE PoE+, 2x GE, 2x Combo RJ45/SFP, 250W PoE Budget		
	52/54		<b>SG6654XHP</b> 48x GE PoE+, 6x 10G SFP+, up to 1440W PoE Budget*, Stacking, RPS			<b>SG3452XMPP</b> 8x GE PoE+, 40x PoE+, 4x 10G SFP+, 800W PoE Budget (TBD) <b>SG3452XP</b> 48x GE PoE+, 4x 10G SFP+, 500W PoE Budget	<b>SG3452P</b> 48x GE PoE+, 4x 1G SFP, 384W PoE Budget		<b>SG2452LP</b> 32x GE PoE+, 16x GE Non-PoE, 4x 1G SFP, 230W PoE Budget (TBD)			

\*The PoE budgets of SG6428XHP and SG6654XHP vary with the power supply modules.

1. All L3 Managed switches are equipped with 1x RJ45 port, 1x Type C-USB Console port, 2x USB ports, and L3/L2+ features including Static Routing, RIP, OSPF, ECMP, VRRP, DHCP Server, DHCP Relay and PIM-DM.

2. All L2+ Managed switches are equipped with 1x RJ45 port, 1x Micro-USB Console port, and L2+/L2 features including Static Routing, 802.1Q VLAN, IGMP Snooping, IPv6 Support, and DHCP Server.

3. RPS refers to Redundant Power Supply, increasing the reliability and making it an ideal choice for reliable networking architecture.

4. Unless otherwise specified, ports refer to RJ45 Ethernet ports



# Omada Easy Smart and Unmanaged Switches



## DS1008X

Omada 8-Port 10G Multi-Gigabit Desktop/Rackmount Switch



## DS105X

Omada 5-Port 10G Multi-Gigabit Desktop Switch



## DS108G-M2

Omada 8-Port 2.5G Multi-Gigabit Desktop Switch



## DS105G-M2

Omada 5-Port 2.5G Multi-Gigabit Desktop Switch

## 10G Multi-Gigabit Unmanaged Switches

Future Networking with Lightning-Fast 10G/Multi-Gig Connections



10G Ports



Optimal 5-Speed Connections



Intelligent Fan Speed\*



Plug & Play



Metal Casing

## 2.5G Multi-Gigabit Unmanaged Switches

Upgrade to a Super-Fast, Futuristic Network Without Changing Cables



2.5G Ports



Hassle-Free Cabling



Silent Operation



Plug & Play



Metal Casing

## PoE Switching to Power Up Your Business



### 250 m PoE Transmission

With Extend Mode, PoE supports data and power transmissions up to 250 m (820 ft) away—perfect for surveillance camera deployment in large areas.



### One-Click Priority Mode

Guarantees the quality of sensitive applications like video monitoring in critical business areas by prioritizing the data of certain ports.



### One-Click Traffic Separation

Isolation Mode easily divides traffic for downlink ports to avoid snooping and tampering and isolates broadcast storm for higher security and performance.



### PoE Auto Recovery

Automatically detects and reboots dropped or unresponsive PoE-powered devices to reduce the possibility of downtime. It also saves maintenance costs by eliminating manual monitoring and rebooting—vital for hard-to-reach devices.



### Silent Operation

Fanless design reduces power consumption and ensures silent operation, ideal for noise-sensitive homes or businesses.<sup>§</sup>





















<sup>§</sup>Certain switches come with a fanless design. Refer to the specification table for details



### Easy to Use

Omada Unmanaged switches are plug and play compatible. Easy Smart switches support plug and play for instant connectivity and simple configuration for additional features. Notice that these two kinds of switches do not support Omada SDN central management.

\*DS105X is fanless for quiet operation

Ports		Easy Smart	Unmanaged			
		1 Gbps	10 Gbps	2.5 Gbps	1 Gbps	10/100 Mbps
Non-PoE	5	 <b>DS105GE</b> 5× GE, Desktop / Wall Mounting	 <b>DS105X</b> 5× 10G, Desktop / Wall Mounting	 <b>DS105G-M2</b> 5× 2.5G, Desktop / Wall Mounting	 <b>DS105G</b> 5× GE, Desktop / Wall Mounting	
	8	 <b>DS108GE</b> 8× GE, Desktop / Wall Mounting	 <b>DS1008X</b> 8× 10G, Rackmount / Desktop	 <b>DS108G-M2</b> 8× 2.5G, Desktop / Wall Mounting	 <b>DS108G</b> 8× GE, Desktop / Wall Mounting	
	16	 <b>DS116GE</b> 16× GE, Desktop / Wall Mounting			 <b>DS1016G</b> 16× GE, Rackmount	
		 <b>DS1016GE</b> 16× GE, Rackmount				
24	 <b>DS1024GE</b> 24× GE, Rackmount			 <b>DS1024G</b> 24× GE, Rackmount		
PoE	5/6			 <b>DS105GP</b> 4-Port PoE+, 65W PoE Budget, Long-Range PoE, PoE Auto Recovery, Desktop / Wall Mounting	 <b>DS106P</b> 4-Port PoE+, 67W PoE Budget, Long-Range PoE, PoE Auto Recovery, Priority Mode, Desktop / Wall Mounting	
				 <b>DS106GPP</b> 1-Port PoE+, 3-Port PoE+, 64W PoE Budget, Long-Range PoE, PoE Auto Recovery, Desktop / Wall Mounting		
	8			 <b>DS108GP</b> 8-Port PoE+, 65W PoE Budget, Long-Range PoE, PoE Auto Recovery, Desktop / Wall Mounting		
	10/11				 <b>DS110GMP</b> 8-Port PoE+, 123W PoE Budget, Long-Range PoE, PoE Auto Recovery, Priority Mode, Isolation Mode, Desktop / Wall Mounting	 <b>DS111P</b> 8-Port FE PoE+, 2× GE + 1× SFP, 65W PoE Budget, Long-Range PoE, PoE Auto Recovery, Isolation Mode, Desktop / Wall Mounting
18				 <b>DS1018GMP</b> 16-Port PoE+, 250W PoE Budget, Long-Range PoE, PoE Auto Recovery, Priority Mode, Isolation Mode, Rackmount		

\*PoE budget calculations are based on laboratory testing. Actual PoE power budget is not guaranteed and will vary as a result of client limitations and environmental factors.

# Omada VPN Routers

## ER8411

Omada VPN Router with 10G Ports



Centralized Management

Two 10GE SFP+ Ports

Up to 10 WAN Ports











Load Balance

OpenVPN/IPSec/PPTP/L2TP/SSL/WireGuard VPN

Powerful Firewall

Multi-Net DHCP











Dual Redundant Power Supplies

	Wired Routers			Wi-Fi Routers	4G Wi-Fi Routers	Integrated Routers	
	GE	2.5GE	10GE	GE	GE	GE	10GE
Premium-Level			 <p><b>ER8411</b></p> <ul style="list-style-type: none"> <li>•Quad-Core 2.2GHz CPU</li> <li>•2x SFP+ + 1x SFP + 8x GE + 2x USB</li> <li>•Up to 10 WAN</li> <li>•IPSec, WireGuard, SSL, OpenVPN</li> <li>•Redundant Power Supply</li> <li>•Rackmount</li> </ul>				 <p><b>ER8411C-M2</b></p> <ul style="list-style-type: none"> <li>•Quad-Core</li> <li>•2-in-1 (Router+Controller)</li> <li>•2x 10G SFP+, 1x 2.5G RJ45, 8x GE RJ45 + 1x USB</li> <li>•Up to 10 WAN</li> <li>•Rackmount</li> </ul>
Enhanced-Level	 <p><b>ER7206</b></p> <ul style="list-style-type: none"> <li>•Dual-Core</li> <li>•1x SFP + 5x GE + 1x USB</li> <li>•Up to 5 WAN</li> <li>•IPSec, WireGuard, SSL, OpenVPN</li> <li>•Desktop/Wall-mount</li> </ul>	 <p><b>ER7412-M2</b></p> <ul style="list-style-type: none"> <li>•Quad-Core</li> <li>•2x 2.5G + 2x SFP + 8x GE + 1x USB</li> <li>•Up to 11 WAN</li> <li>•IPSec, WireGuard, SSL, OpenVPN</li> <li>•Rackmount/Desktop</li> </ul>  <p><b>ER707-M2</b></p> <ul style="list-style-type: none"> <li>•Dual-Core</li> <li>•2x 2.5G + 1x SFP + 4x GE + 1x USB</li> <li>•Up to 6 WAN</li> <li>•IPSec, WireGuard, SSL, OpenVPN</li> <li>•Desktop/Wall-mount</li> </ul>		 <p><b>ER706W</b></p> <ul style="list-style-type: none"> <li>•Dual-Core</li> <li>•1x SFP + 5x GE + 1x USB</li> <li>•Up to 5 WAN</li> <li>•AX3000 Wi-Fi 6 (2+2)</li> <li>•IPSec, WireGuard, SSL, OpenVPN</li> <li>•Desktop/Wall-mount</li> </ul>	 <p><b>ER706W-4G</b></p> <ul style="list-style-type: none"> <li>•Dual-Core</li> <li>•1x SFP + 5x GE</li> <li>•Up to 5 WAN</li> <li>•AX3000 Wi-Fi 6 (2+2)</li> <li>•4G+ Cat6 300Mbps Download</li> <li>•IPSec, WireGuard, SSL, OpenVPN</li> <li>•Desktop/Wall-mount</li> </ul>	 <p><b>ER7212PC</b></p> <ul style="list-style-type: none"> <li>•Dual-Core</li> <li>•3-in-1 (Router + Controller + PoE output)</li> <li>•2x SFP + 10x GE</li> <li>•Up to 4 WAN</li> <li>•IPSec VPN, OpenVPN</li> <li>•8x PoE+ GE Ports, 110W PoE Budget</li> <li>•Desktop/Wall-mount</li> </ul>	
Entry-Level	 <p><b>ER605</b></p> <ul style="list-style-type: none"> <li>•Dual-Core</li> <li>•5x GE + 1x USB</li> <li>•Up to 3 WAN</li> <li>•IPSec, WireGuard, OpenVPN</li> <li>•Desktop/Wall-mount</li> </ul>			 <p><b>ER605W</b></p> <ul style="list-style-type: none"> <li>•Single-Core</li> <li>•5x GE</li> <li>•Up to 3 WAN</li> <li>•AC1350 Wi-Fi 5 (450+867)</li> <li>•IPSec VPN</li> <li>•Desktop/Wall-mount</li> </ul>			

# Omada Accessories













## Omada PoE Adapters



	PoE Injectors			PoE Splitter	PoE Extender	Passive PoE Adapters
	GE	2.5GE	10GE	GE	FE	
802.3bt	 <p><b>POE170S</b></p> <ul style="list-style-type: none"> <li>• 2x GE Ports</li> <li>• 802.3af/at/bt type 3</li> <li>• 60 W PoE Power</li> <li>• Desktop / Wall Mounting</li> <li>• 155x70x42 mm</li> </ul>		 <p><b>POE380S</b></p> <ul style="list-style-type: none"> <li>• 2x 10GE Ports</li> <li>• 802.3af/at/bt type3/bt type4</li> <li>• 90 W PoE Power</li> <li>• Desktop / Wall Mounting</li> <li>• 155x70x42 mm</li> </ul>			 <p><b>POE4824G</b></p> <ul style="list-style-type: none"> <li>• 1x GE Non-PoE Input Port</li> <li>• 1x GE Passive PoE Output Port</li> <li>• Up to 24 W PoE Power (Max 48 VDC)</li> <li>• Desktop / Wall Mounting</li> <li>• 110x57x38.8 mm</li> </ul>
802.3at	 <p><b>POE160S</b></p> <ul style="list-style-type: none"> <li>• 2x GE Ports</li> <li>• 802.3af/at</li> <li>• 30 W PoE Power</li> <li>• Desktop / Wall Mounting</li> <li>• 125x59.4x36.8 mm</li> </ul>	 <p><b>POE260S</b></p> <ul style="list-style-type: none"> <li>• 2x 2.5GE Ports</li> <li>• 802.3af/at</li> <li>• 30 W PoE Power</li> <li>• Desktop / Wall Mounting</li> <li>• 125x59.4x36.8 mm</li> </ul>			 <p><b>POE10E</b></p> <ul style="list-style-type: none"> <li>• 2x FE PoE Port (1x PoE in, 1x PoE out)</li> <li>• Compatible with 802.3af/at PSE and PD devices</li> <li>• Desktop</li> <li>• 71x26x16.2mm</li> </ul>	 <p><b>POE4818G</b></p> <ul style="list-style-type: none"> <li>• 1x GE Non-PoE Input Port</li> <li>• 1x GE Passive PoE Output Port</li> <li>• Up to 18 W PoE Power (Max. 48 VDC)</li> <li>• Desktop / Wall Mounting</li> <li>• 85.8x43.9x35 mm</li> </ul>
802.3af	 <p><b>POE150S</b></p> <ul style="list-style-type: none"> <li>• 2x GE Ports</li> <li>• 802.3af</li> <li>• 15.4 W PoE Power</li> <li>• Desktop</li> <li>• 80.8x54x24 mm</li> </ul>			 <p><b>POE10R</b></p> <ul style="list-style-type: none"> <li>• 2x GE PoE port</li> <li>• 1 power socket (DC OUT 5/9/12V)</li> <li>• 802.3af</li> <li>• Desktop</li> <li>• 80.8x54x24mm</li> </ul>		 <p><b>POE2412G</b></p> <ul style="list-style-type: none"> <li>• 1x GE Non-PoE Input Port</li> <li>• 1x GE Passive PoE Output Port</li> <li>• Up to 12 W PoE Power (Max. 24 VDC)</li> <li>• Desktop / Wall Mounting</li> <li>• 85.8x43.9x35 mm</li> </ul>





# Omada Media Converters

● MC Series: 9 VDC, 0.6 A input    ● FC Series: 5 VDC, 0.6 A input    ● FC PoE: 48 VDC, 0.5 A input

Max Transmission	100 Mbps					Gigabit			
	Multi-Mode Dual Fiber	Single-Mode Dual Fiber	Single-Mode Single Fiber		Single-Mode Single Fiber with PoE Output	Multi-Mode Dual Fiber	Single-Mode Dual Fiber	Single-Mode Single Fiber	SFP Module
20 km		 <p><b>MC110CS</b></p> <ul style="list-style-type: none"> <li>• 2x SC Fiber Ports</li> <li>• 1x FE RJ-45 Port</li> <li>• 1310 nm</li> </ul>	 <p><b>MC111CS / MC112CS</b></p> <ul style="list-style-type: none"> <li>• WDM</li> <li>• 1x SC Fiber Port</li> <li>• 1x FE RJ-45 Port</li> <li>• MC111CS: 1550/1310 nm</li> <li>• MC112CS: 1310/1550 nm</li> </ul>	 <p><b>FC111A-20 / FC111B-20</b></p> <ul style="list-style-type: none"> <li>• WDM</li> <li>• 1x SC Fiber Port</li> <li>• 1x FE RJ-45 Port</li> <li>• A-20: 1550/1310 nm</li> <li>• B-20: 1310/1550 nm</li> </ul>	 <p><b>FC111PB-20</b></p> <ul style="list-style-type: none"> <li>• WDM</li> <li>• 1x SC Fiber Port</li> <li>• 1x FE 802.3af RJ-45 Port</li> <li>• 1310/1550 nm</li> <li>• 48 VDC / 0.5 A Input</li> <li>• 802.3af PoE Output</li> </ul>		 <p><b>MC210CS</b></p> <ul style="list-style-type: none"> <li>• 2x SC Fiber Ports</li> <li>• 1x GE RJ-45 Port</li> <li>• 1310 nm</li> </ul>	 <p><b>FC311A-20 / FC311B-20</b></p> <ul style="list-style-type: none"> <li>• WDM</li> <li>• 1x SC Fiber Port</li> <li>• 1x GE RJ-45 Port</li> <li>• A-20: 1550/1310 nm</li> <li>• B-20: 1310/1550 nm</li> </ul>	 <p><b>MC220L</b></p> <ul style="list-style-type: none"> <li>• Maximum distance depends on the inserted SFP module</li> <li>• 1x 1000 Mbps SFP Slot</li> <li>• 1x GE RJ-45 Port</li> </ul>
2 km	 <p><b>MC100CM</b></p> <ul style="list-style-type: none"> <li>• 2x SC Fiber Ports</li> <li>• 1x FE RJ-45 Port</li> <li>• 1310 nm</li> </ul>							 <p><b>FC311A-2 / FC311B-2</b></p> <ul style="list-style-type: none"> <li>• WDM</li> <li>• 1x SC Fiber port</li> <li>• 1x GE RJ-45 Port</li> <li>• A-2: 1550nm/1310nm</li> <li>• B-2: 1310nm/1550nm</li> </ul>	
550 m						 <p><b>MC200CM</b></p> <ul style="list-style-type: none"> <li>• 0.55 km or 0.22 km</li> <li>• 2x SC Fiber Ports</li> <li>• 1x GE RJ-45 Port</li> <li>• 850 nm</li> </ul>			

	Chassis
FC Series	 <p><b>FC1420</b></p> <ul style="list-style-type: none"> <li>• 14 bays to house up to 14 media converters</li> <li>• 2U 19-inch Rack-mountable</li> <li>• 14x 5VDC/0.6A output</li> <li>• Redundant Power Supply</li> </ul>
MC Series	 <p><b>MC1400</b></p> <ul style="list-style-type: none"> <li>• 14 bays to house up to 14 media converters</li> <li>• 2U 19-inch Rack-mountable</li> <li>• 14x 9 VDC / 0.6 A output</li> <li>• Redundant Power Supply</li> </ul>

# Omada SFP/SFP+ Modules

Max Transmission	SFP/SFP+ Modules		SFP/SFP+ RJ45 Modules
	1G SFP Modules	10G SFP+ Modules	
20 km	 <p><b>SM321A / SM321B</b></p> <ul style="list-style-type: none"> <li>• 9/125 μm Single-mode Fiber</li> <li>• WDM Bi-Directional</li> <li>• 1× LC Port</li> <li>• A: 1550 nm / 1310 nm</li> <li>• B: 1310 nm / 1550 nm</li> </ul>	 <p><b>SM311LS</b></p> <ul style="list-style-type: none"> <li>• 9/125 μm Single-mode Fiber</li> <li>• Transmit distance: 20 km</li> <li>• 2× LC Ports</li> <li>• Wave length: 1310 nm</li> </ul>	 <p><b>SM5310-T</b></p> <ul style="list-style-type: none"> <li>• XFI MAC interface</li> <li>• 10GBASE-T: UTP cat.6a or above (max 30m)</li> <li>• 1000BASE-T/ 2.5GBASE-T/ 5GBASE-T: UTP cat.5e or above (max 100m)</li> <li>• Hot Swappable</li> <li>• DDM</li> <li>• Plug &amp; Play</li> </ul>
10 km		 <p><b>SM5110-LR</b></p> <ul style="list-style-type: none"> <li>• 10 Gbps</li> <li>• 9/125 μm Single-mode Fiber</li> <li>• 2× LC Ports</li> <li>• Wave length: 1310 nm</li> </ul>	
2 km	 <p><b>SM321A-2 / SM321B-2</b></p> <ul style="list-style-type: none"> <li>• 9/125 μm Single-mode Fiber</li> <li>• WDM Bi-Directional</li> <li>• 1× LC Port</li> <li>• A-2: 1550 nm / 1310 nm</li> <li>• B-2: 1310 nm / 1550 nm</li> </ul>		
550m / 300m	 <p><b>SM311LM</b></p> <ul style="list-style-type: none"> <li>• 50/125 μm or 62.5/125 μm Multi-mode Fiber</li> <li>• Transmit distance: 550 m or 275 m</li> <li>• 2× LC Ports</li> <li>• Wave length: 850 nm</li> </ul>	 <p><b>SM5110-SR</b></p> <ul style="list-style-type: none"> <li>• 10 Gbps</li> <li>• 50/125 μm or 62.5/125 μm Multi-mode Fiber</li> <li>• Transmit distance: 300 m or 33 m</li> <li>• 2× LC Ports</li> <li>• Wave length: 850 nm</li> </ul>	 <p><b>SM331T</b></p> <ul style="list-style-type: none"> <li>• 1000BASE-X MAC interface</li> <li>• 1000BASE-T: UTP cat.5e or above (max 100m)</li> <li>• Hot Swappable</li> <li>• Plug &amp; Play</li> </ul>

# Omada Reverse PoE Switches

The 8-Port Gigabit Managed Reverse PoE Switch RP108GE has seven gigabit PoE input ports that allow it to receive power from user outlets via PoE injectors. Equipped with one PoE output port, the switch can supply power to CPEs and similar devices via Port 8. The DC output port supports both 5 V and 12 V optional output voltage and can be used to power devices like ONTs. Enhanced with basic management features like VLAN and QoS, RP108GE shares the same software functions with Omada Easy Smart switches.

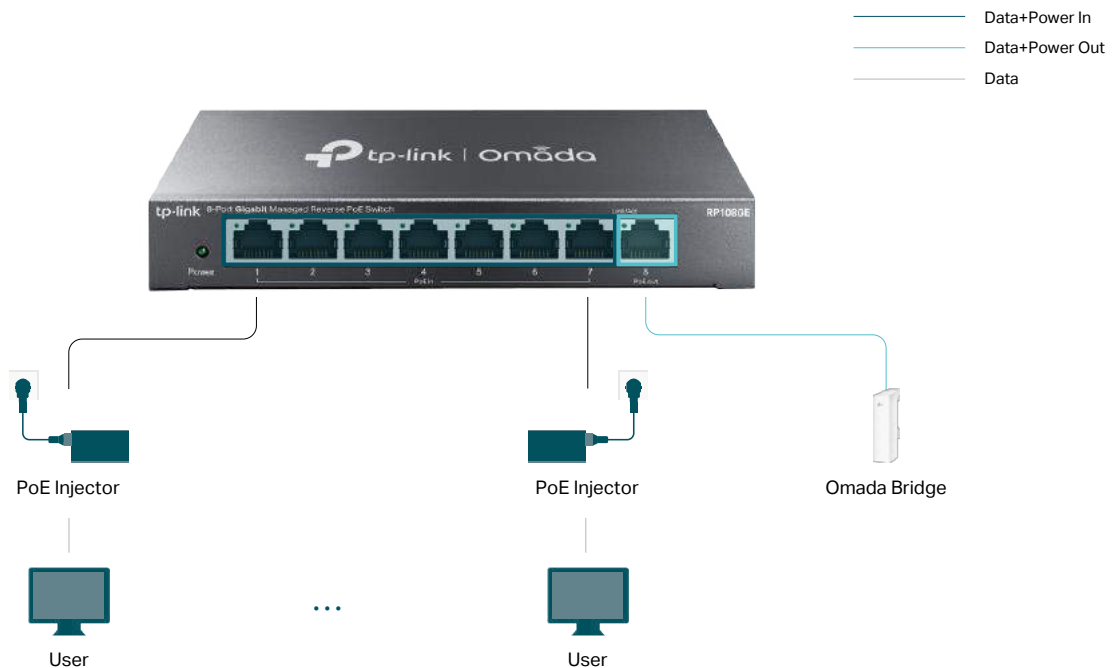

# Typical Solutions for Industries and Scenarios

## Omada Is Ideal for Small and Mid-Size Business (SMB)

TP-Link Omada is specially designed for hotels, schools, restaurants, offices, and more. Scenario-based products and rich benefits satisfy different needs in various environments.

### Typical Solutions for Industries



#### Hotels

- Full Wi-Fi coverage and wired connections
- Hybrid controller options and easy management
- Flexible guest Wi-Fi policy
- Seamless roaming
- PPSK



#### Schools

- 1K+ high-density Wi-Fi
- Flexible guest/staff/student authentication
- Flexible controller options and easy management
- Enterprise VPN and security



#### Offices

- Enterprise VPN and security
- Portal and 802.1X staff authentication
- Flexible controller options and easy management
- Content filter and monitoring



#### Restaurants

- 1K+ high-density Wi-Fi
- Stable wireless online ordering system
- Boost business through Wi-Fi marketing
- Seamless roaming
- Easy management

### Typical Solutions for Scenarios



PoE Switches for Surveillance



Long-range Wi-Fi for Surveillance



Wireless Networking for Elevators



Wi-Fi for Warehouses



High-Density Wi-Fi



Wi-Fi for Outdoors

(Park & Beach, Outdoor Event, Yard, Swimming Pool, Outdoor Café, Parking Lot, Parks, and more)

# Omada Solution for Hotels



Your customers demand a strong, stable wireless network. Improve customer satisfaction and user-generated ratings with TP-Link Omada. Build the cost-effective wireless network for your hotel that drives better reviews and brings loyal customers back.

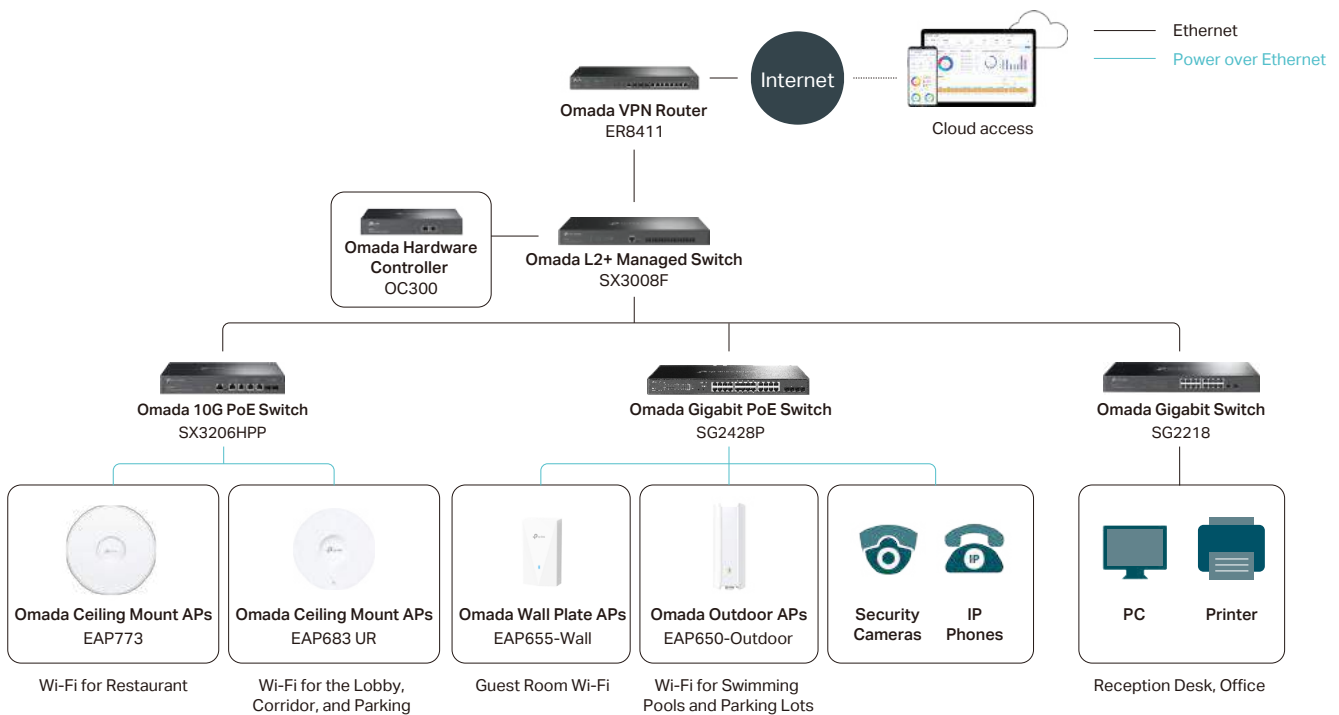

Mid-Size Hotel			
Product	Model	Role	Features
Controllers	OC300	Management	Hardware Controller without running PCs; Manage up to <b>700 devices</b> ; Free cloud access
Routers	ER8411	Gateway	<b>2x 10G SFP+</b> ports; 1x Gigabit SFP port + 8x Gigabit RJ45 ports; Up to <b>10 WAN</b> ports; Firewall; Enterprise-level VPN; Redundant power supplies; LTE Backup with USB dongle
Switches	SX3008F	Core Layer	Full 10G Connections; <b>8x 10G SFP+</b> ports
	SX3206HPP	Connecting APs with Multi-Gigabit PoE Ports	<b>4x 10G PoE++</b> RJ45 ports; <b>2x 10G SFP+</b> ports; <b>200 W PoE</b> budget; Max. 60 W PoE out per port
	SG2428P	Connecting APs, IP Cameras, and IP Phones	<b>24x PoE+</b> Gigabit RJ45 ports; 4x Gigabit SFP ports; <b>250 W PoE</b> budget
	SG2218	Connecting PCs	<b>16x Gigabit</b> RJ45 ports; 2x Gigabit SFP ports
Ceiling Mount APs	EAP773	Wi-Fi for restaurant and meeting room	<b>Wi-Fi 7</b> ; Up to <b>11 Gbps</b> Wi-Fi speed; 1x <b>10G</b> RJ45 ports; Bluetooth; Mesh; Seamless roaming; Captive portal; 802.3at/bt PoE power supply
	EAP683 UR	Wi-Fi for the lobby, corridor, and parking	Wi-Fi 6; Up to <b>6 Gbps</b> Wi-Fi speed; 1x <b>2.5G</b> RJ45 port; Long-range coverage; Mesh; Seamless roaming; Captive portal; 802.3at PoE power supply
Wall Plate APs	EAP655-Wall	Guest room Wi-Fi	Wi-Fi 6; Full in-room Wi-Fi coverage; Up to <b>3.0 Gbps</b> Wi-Fi speed; Seamless roaming; Captive portal; <b>4x Gigabit</b> RJ45 ports; Supports 802.3af/at PoE input and PoE passthrough
Outdoor APs	EAP650-Outdoor	Wi-Fi for swimming pools and parking lots	Wi-Fi 6; Long-range outdoor coverage; Up to <b>3.0 Gbps</b> Wi-Fi speed; 1x Gigabit RJ45 port; Supports 802.3at and Passive PoE; Mesh; Seamless roaming; <b>IP67</b> weatherproof enclosure



Small Hotel			
Product	Model	Role	Features
Controllers	OC200	Management	Hardware Controller without running PCs; Manage up to <b>130 devices</b> ; Free cloud access; 802.3af/at PoE or Micro USB power supply
Routers	ER707-M2	Gateway	<b>2x 2.5G</b> + 1x SFP + 4x GE ports; Up to <b>6 WAN</b> ports; Multi-WAN Load Balancing; Firewall; Enterprise-level Wireguard/IPSec/OpenVPN; LTE Backup with USB dongle
Switches	SG2218P	Connecting Access Points, IP Cameras, and IP Phones	<b>16x PoE+</b> Gigabit RJ45 ports; 2x Gigabit SFP ports; <b>150 W PoE</b> budget
	SG2008	Connecting PCs	<b>8x Gigabit</b> RJ45 ports
Ceiling Mount APs	EAP653	Wi-Fi for restaurant	Wi-Fi 6; Up to <b>3.0 Gbps</b> Wi-Fi speed; 1x Gigabit RJ45 port; Mesh; Seamless roaming; Captive portal; 802.3at PoE / 48V Passive PoE power supply
	EAP613	Wi-Fi for the lobby, corridor and parking	Wi-Fi 6; Up to <b>1.8 Gbps</b> Wi-Fi speed; 1x Gigabit RJ45 port; Mesh; Seamless roaming; Captive portal; 802.3at PoE / 48V Passive PoE power supply
Wall Plate APs	EAP615-Wall	Guest room Wi-Fi	Wi-Fi 6; Full in-room Wi-Fi coverage; Up to <b>1.8 Gbps</b> Wi-Fi speed; Thin design; Captive portal; <b>4x Gigabit</b> RJ45 ports; Supports 802.3af/at PoE input and PoE passthrough
Outdoor APs	EAP610-Outdoor	Wi-Fi for swimming pool and outdoor parking	Wi-Fi 6; Up to <b>1.8 Gbps</b> Wi-Fi speed; 1x Gigabit RJ45 port; 802.3at and Passive PoE power supply; Mesh; Seamless roaming; <b>IP67</b> weatherproof enclosure

## Omada Solution Benefits

### 1. NETWORK CONNECTIVITY MUST BE ALWAYS-ON AND AUTOMATED

Performance of the network must always deliver an exceptional guest experience. When hoteliers unify all network operations, it increases their ability to focus on guests, not on whether devices are connecting.



#### High-Performance and Full-Coverage Wireless Networks, Even in High-Density Environments

Omada's Wi-Fi 7 and Wi-Fi 6 infrastructure is designed to support hundreds of guests and associate devices simultaneously without impacting Wi-Fi quality. Critical applications can be prioritized so they can perform at their peak without impacting the guest or staff experience.



#### One-Click Wi-Fi Performance Optimization with Automatic Channel Selection and Power Adjustment

With AI algorithms, Omada provides powerful wireless performance while greatly reducing Wi-Fi interference by automatically adjusting the channel settings and transmission power levels of neighboring APs in guest rooms.



#### Stable Wired Connections from Edge to Core

Omada provides smart switches, L2+ Managed switches, and campus switches, meeting the needs of reliable networking from edge to core. High-speed wired connections are provided with 25G, 10G, 2.5G, or 1G Ethernet ports. Available 802.3bt PoE+, 802.3at PoE+, and 802.3af PoE further benefit network deployment.



#### AI Roaming for Uninterrupted Streaming

Ensure guests and staff enjoy uninterrupted streaming when moving around by switching clients automatically to the access points with the optimal signal. AI Roaming facilitates Fast Roaming and further optimizes the roaming experience.

### 2. NETWORK SECURITY SHOULD ALWAYS BE ASSURED

Guests' information and privacy should be well protected. Real-time network statistics monitoring and abundant security functions protect the network and free guests from worrying about the insecurity of public Wi-Fi.



#### Know What's On the Network

Omada's easy-to-use dashboard lets you see your real-time network status and check network usage and traffic distribution. The network topology intelligently identifies and visually displays network devices and clients, helping IT admins quickly see and troubleshoot connections at a glance.



#### Protects Hotel Networks from Threats

A robust firewall and advanced security functions further protect the network and data. Attack Defense, high-security VPN, Access Control, advanced WPA3 encryption, Captive Portal, Guest Authentication, MAC-Based Authentication, PPSK, device security detection and protection, and URL identification and filtering are provided.



#### Real-Time Health Status and Full Report of Clients, Devices, WAN, and Wi-Fi

Monitor device, WAN, Wi-Fi, and client health across the network for scoring and analysis, aiding administrators in identifying and enhancing network performance, and addressing network irregularities. Select network health statistics for customizable time periods.



#### Abnormal Event Warnings and Notifications

Automatically display and analyze abnormal events found in the network, and rank high-frequency accident devices and clients so that network administrators can quickly locate abnormal network devices.



#### Better Protection for Guests' Privacy

TP-Link Omada separates network management data from user data, with no user traffic passing through the cloud, ensuring better protection for users' privacy.



#### Two-Factor Authentication Enhances Account Security

Dramatically improves the security of your network management account and all the personal information you store with TP-Link.

### 3. STABILITY MATTERS FOR GUEST EXPERIENCE



#### AIOps for Quick Troubleshooting

Locate network faults, warn and notify administrators, and analyze potential network problems even when the IT manager is away with Omada's easy-to-use management interface and AI-Driven technology. Omada notifies administrators when a device fails or goes offline, before it impacts users.



#### Multiple-Factor Guarantee Higher Reliability

Higher reliability of cloud service is guaranteed with 99.9% SLA availability, 24/7 automated fault detection, geographically isolated back-up servers, and reliable product quality. A series of reliability-assured designs like redundant power supplies of switches and routers, PoE Auto Recovery, and AIOps ensure non-stop operation even in the event of a fault.

### 4. BOOST ASSETS AND GUEST EXPERIENCES



#### Boost Online Business with Customized Pages

Boost online business through guest Wi-Fi with authentication pages, which display promotional or marketing content.



#### Flexible Guest Management

Automatically detect and flexibly manage guest clients. Set the clients with Bandwidth Management, Device Limit, Time Period, and Data Quota to match your hotel operation strategy.

## Typical Cases

### Hotels in Bukit Bintang

**Name:** Hotels in Bukit Bintang  
**Location:** Kuala Lumpur, Malaysia  
**Products:** 1021× APs, 46× Switches, 3× Routers



#### Benefits

Omada solutions deliver reliable Wi-Fi, enhancing the hospitality experience at Bukit Bintang, with customers expressing high satisfaction with the outcomes.

#### Testimonials

"The Omada Solution has empowered my business. Customers from all over the world can now enjoy the free Wi-Fi, and I have had no complaints since upgrading."  
 —Kenneth, owner of Anggun Boutique Hotel.

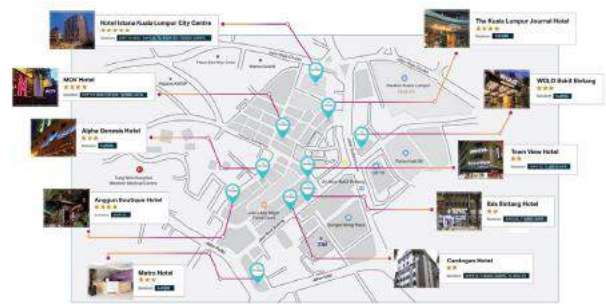

"We chose the TP-Link Omada whole solution for its extreme cost-efficiency and high stability. The whole solution simplified my work so much and increased our guests' overall experience."  
 —Chris, IT Manager of 5-star Hotel Istana

### Sailor's Beach Club

**Name:** Sailor's Beach Club (5-Star Hotel)  
**Capacity:** 336 Rooms  
**Location:** Turkey  
**Products:** 373× APs, 17× Switches



#### Benefits

Sailor's Beach Club is highly satisfied with the Omada system, which has delivered the reliable network performance they required. Essential network needs, including primary and secondary backbone connectivity, seamless guest access, and franchise Wi-Fi services, are now effortlessly met.

# Omada Solution for Schools



The smart classroom, enabled by digital learning technology, enhances children's educational experiences. TP-Link Omada is renowned for offering wired, wireless, or hybrid solutions to educational institutions. Our scalable and secure network solutions protect campus resources and facilitate extensive remote working and learning opportunities.

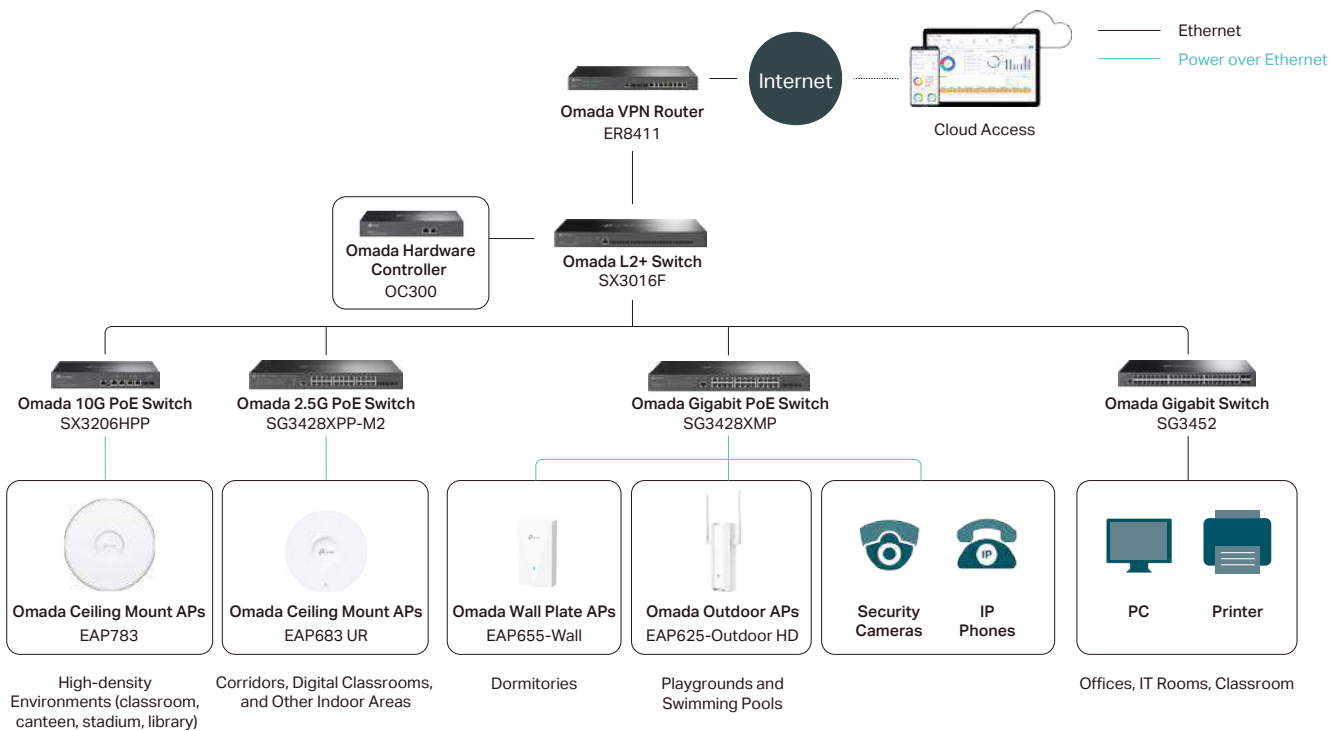

Mid-Size School			
Product	Model	Role	Features
Controllers	OC300	Management	Hardware Controller without running PCs; Manage up to <b>700 devices</b> ; Free cloud access
	Cloud-Based Controller		Completely in the cloud; Unlimited management scale; <b>Zero-Touch Provisioning</b>
Routers	ER8411	Gateway	<b>2x 10G SFP+</b> ports; 1x Gigabit SFP port + 8x Gigabit RJ45 ports; Up to <b>10 WAN</b> ports; Firewall; Enterprise-level VPN; Redundant power supplies; LTE Backup with USB dongle
Switches	SX3016F	Core Layer	<b>Full 10G</b> Connections; <b>16x 10G SFP+</b> ports; Redundant power supplies
	SX3206HPP	Connecting AP with 10G PoE Port	<b>4x 10G PoE++</b> RJ45 ports; <b>2x 10G SFP+</b> ports; <b>200 W PoE</b> budget; Max. <b>60 W PoE</b> out per port
	SG3428XPP-M2	Connecting AP with 2.5G PoE Port	<b>8x 2.5G PoE++</b> ports (Max. <b>60 W PoE</b> out per port); <b>16x 2.5G PoE+</b> ports; <b>4x 10G SFP+</b> ports; <b>500W PoE</b> budget
	SG3428XMP	Connecting IP Cameras and IP Phones	<b>24x PoE+</b> Gigabit RJ45 ports; <b>4x 10G SFP+</b> ports; <b>384 W PoE</b> budget
	SG3452	Connecting PCs	<b>48x Gigabit</b> RJ45 ports; 4x Gigabit SFP ports
Ceiling Mount APs	EAP783	Wi-Fi for High-density environments (classroom, canteen, stadium, library)	<b>Wi-Fi 7</b> ; Improves efficiency in high-density environments; Up to <b>22 Gbps</b> Wi-Fi speed; <b>2x 10G</b> RJ45 ports; Bluetooth; Mesh; Seamless roaming; Captive portal; 802.3bt PoE power supply
	EAP683 UR	Wi-Fi for Corridor, digital classroom, other indoor areas	Wi-Fi 6; Up to <b>6.0 Gbps</b> Wi-Fi speed; <b>1x 2.5G</b> RJ45 port; Mesh; Seamless roaming; Captive portal; 802.3at PoE power supply
Wall Plate APs	EAP655-Wall	Dormitory Wi-Fi	Wi-Fi 6; Full in-room Wi-Fi coverage; Up to <b>3.0 Gbps</b> Wi-Fi speed; Seamless roaming; Captive portal; <b>4x Gigabit</b> RJ45 ports; Supports 802.3af/at PoE input and PoE passthrough
Outdoor APs	EAP625-Outdoor HD	Wi-Fi for playground and swimming pool	Wi-Fi 6; Long-range outdoor coverage; Up to <b>1.8 Gbps</b> Wi-Fi speed; 1x Gigabit RJ45 port; Supports 802.3at and Passive PoE; Mesh; Seamless roaming; <b>IP67</b> weatherproof enclosure

Small School			
Product	Model	Role	Features
Controllers	OC200	Management	Hardware Controller without running PCs; Manage up to <b>130 devices</b> ; Free cloud access; 802.3af/at PoE or Micro USB power supply
Routers	ER7206	Gateway	<b>5× Gigabit</b> RJ45 ports + 1× Gigabit SFP port; Up to <b>5 WAN</b> ports; Multi-WAN Load Balancing; Firewall; Enterprise-level SSL/Wireguard/IPSecVPN; LTE Backup with USB dongle
Switches	SG3428XF	Core Layer	<b>20× SFP</b> , 4× RJ45/SFP Combo Gigabit ports; <b>4× 10G SFP+</b> ports; Redundant power supplies
	SG3210XHP-M2	Connecting AP with 2.5G PoE Port	<b>8× 2.5G PoE+</b> RJ45 ports; <b>2× 10G SFP+</b> ports; <b>240 W PoE</b> budget
	SG2428P	Connecting IP Cameras and IP Phones	<b>24× PoE+</b> Gigabit RJ45 ports; 4× Gigabit SFP ports; <b>250 W PoE</b> budget
	SG3428	Connecting PCs	<b>24× Gigabit</b> RJ45 ports; 4× Gigabit SFP ports
Ceiling Mount APs	EAP660 HD	Wi-Fi for High-density environments (classroom, canteen, stadium, library)	Wi-Fi 6; Up to <b>3.6 Gbps</b> Wi-Fi speed; <b>1× 2.5G</b> RJ45 port; 4×4 MIMO antennas; Concurrent clients up to <b>1024</b> ; Mesh; Seamless roaming; Captive portal; 802.3at PoE / 12V DC power supply
	EAP613	Wi-Fi for Corridor, digital classroom, other indoor areas	Wi-Fi 6; Up to <b>1.8 Gbps</b> Wi-Fi speed; 1× Gigabit RJ45 port; Mesh; Seamless roaming; Captive portal; 802.3at PoE power supply
Wall Plate APs	EAP615-Wall	Dormitory Wi-Fi	Wi-Fi 6; Full in-room Wi-Fi coverage; Up to <b>1.8 Gbps</b> Wi-Fi speed; Thin design; Captive portal; <b>4× Gigabit</b> RJ45 ports; Supports 802.3af/at PoE input and PoE passthrough
Outdoor APs	EAP623-Outdoor HD	Wi-Fi for playground and swimming pool	Wi-Fi 6; Up to <b>1.8 Gbps Wi-Fi</b> speed; High-capacity connectivity; 1× Gigabit RJ45 port; 802.3at and Passive PoE power supply; <b>Mesh</b> ; Seamless roaming; <b>IP67</b> weatherproof enclosure

## Omada Solution Benefits

### 1. NETWORK CONNECTIVITY MUST BE UNIFIED, ALWAYS-ON, AND AUTOMATED

The performance of the network must always deliver an exceptional user experience. When educators unify all network operations, it increases their ability to focus on education and students, not on whether devices are connecting.



#### High-Performance and Full-Coverage Wireless Networks, Even in High-Density Environments

Omada's Wi-Fi 7 and Wi-Fi 6 infrastructure is designed to support campuses of any size with always-on secure connectivity. Simultaneous connections to hundreds of devices without impacting Wi-Fi quality are supported, with concurrent clients up to 1000+.



#### Stable Wired Connections from Edge to Core

Omada provides smart switches, L2+ Managed switches, and L3 Managed switches, meeting the needs of reliable networking from edge to core. High-speed wired connections are provided with 25G, 10G, 2.5G, or 1G Ethernet ports.



#### One-Click Wi-Fi Performance Optimization with Automatic Channel Selection and Power Adjustment

Provides powerful wireless performance while greatly reducing Wi-Fi interference in classrooms and dormitories. Omada uses AI algorithms to automatically optimize Wi-Fi channel selection and transmit power according to the network environment.



#### AI Roaming for Uninterrupted Streaming

Ensure students, teachers, and staff enjoy uninterrupted streaming when moving around by switching clients automatically to the access points with the optimal signal.

### 2. NETWORK SECURITY SHOULD ALWAYS BE ASSURED

Cybersecurity is always the primary assurance when establishing a campus network. Student information and privacy, academic data, and teaching materials of teachers must be protected.



#### Know What's On the Network

Omada's easy-to-use dashboard lets you see your real-time network status and check network usage and traffic distribution. The network topology intelligently identifies and visually displays network devices and clients, helping IT admins quickly see and troubleshoot connections at a glance.



#### Secure Network with Authentication

Provide secure Wi-Fi access to authorized users (students, teachers, and staff) with multiple authentication options (802.1X/Radius/Local Database). Optional Guest Network provides secure access to guests visiting your campus.



#### Protects Campus Networks from Threats

A robust firewall and advanced security functions protect the network and data. Attack Defense, high-security VPN, Access Control, advanced WPA3 encryption, Captive Portal, 802.1X Authentication, MAC-Based Authentication, PPSK, device security detection and protection, URL identification and filtering, MAC Filtering, IP-MAC-Port Binding, and VLAN Binding are provided.



#### Separate Student, Staff, and IoT Traffic

Assign VLANs to each client to segment users and enhance security. Policies are carried across the network end-to-end, regardless of the location of the user or device or the switch port carrying the traffic. Now, student learning traffic is isolated from student records, public safety cameras, and administrative traffic. MAC-Based Authentication can realize MAC security authentication for IoT devices.





### Real-Time Health Status and Full Report of Clients, Devices, WAN, and Wi-Fi

View the health of devices, WAN, Wi-Fi, and clients in the entire network for scoring and analysis, assisting network administrators to recognize and improve network health, and adjust network anomalies. Network health-related statistics can be flexibly selected for specific time periods.



### Better Protection for Students' Privacy

TP-Link Omada separates network management data from user data, with no user traffic passing through the cloud, ensuring better protection for users' privacy.



### Abnormal Event Warnings and Notifications

Automatically display and analyze abnormal events found in the network, and rank high-frequency accident devices and clients so that network administrators can quickly locate abnormal network devices.



### Two-Factor Authentication Enhances Account Security

Dramatically improves the security of your network management account and all the personal information you store with TP-Link.

## 3. STABILITY MATTERS FOR DIGITAL LEARNING



### AI Ops for Quick Troubleshooting

Locate network faults, warn and notify administrators, and analyze potential network problems even when the IT manager is away with Omada's easy-to-use management interface. Omada notifies administrators when a device fails or goes offline, before it impacts users.



### Multiple-Factor Guarantee Higher Reliability

Higher reliability of cloud service is guaranteed with 99.99% SLA availability and 24/7 automated fault detection. A series of reliability-assured designs like redundant power supplies of switches and routers, PoE Auto Recovery, and AI Ops ensure non-stop operation even in the event of a fault.

## 4. FACILITATING EFFICIENCY AND MANAGEMENT



### Flexible Criteria Management

Use different SSIDs, Access Control, and VLAN binding technologies to identify key network user profiles to deploy customized operating criteria. Set the clients with Bandwidth Management and Time Period to match the school's strategy.



### Broadcast Important Policies with Customized Pages

Display special news or important policies and reminders through a customized authentication page when users connect to the campus Wi-Fi.



### Online Behavior Moderation

Online behaviors of students and teachers should be moderated across campus. Users need to focus on education, not entertainment. Easily specify the internet access rights and strategies of students and teachers via IP/MAC/URL Filtering and Access Control List (ACL).



### Study from Home with VPN Technology

COVID-19 accelerated the use of online platforms. Distance learning solutions were developed all over the world seeking continuous education. Omada provides secure and enterprise-standard OpenVPN/IPSec/PPTP/L2TP/SSL/WireGuard VPN to allow students or teachers to visit the campus network even at home. Simultaneously, the networks of each campus can access the intranet of each other.

## Typical Cases

### The King's Hospital School

**Name:** The King's Hospital School  
**Capacity:** 80-acre campus, 300+ students  
**Location:** Ireland  
**Products:** 70x APs, 10x Switches

Scan for more info



### Habitat School

**Name:** Habitat School  
**Capacity:** 1,000 Clients  
**Location:** Ajman, UAE

Scan for more info





Simplicity and functionality are the key principles for designing a small and medium-sized office network setup. To drive business growth, offices require reliable network systems involving more clients—both wired and wireless—more bandwidth-demanding applications, and more customized services like VPN. Omada, a Software-Defined Networking solution, provides one-stop access to high-quality services and high-performance products, ideal for use in small to mid-size offices.

## Typical Solution Topology and Product Recommendations

### 1. Small Offices (Less Than 50 Employees)

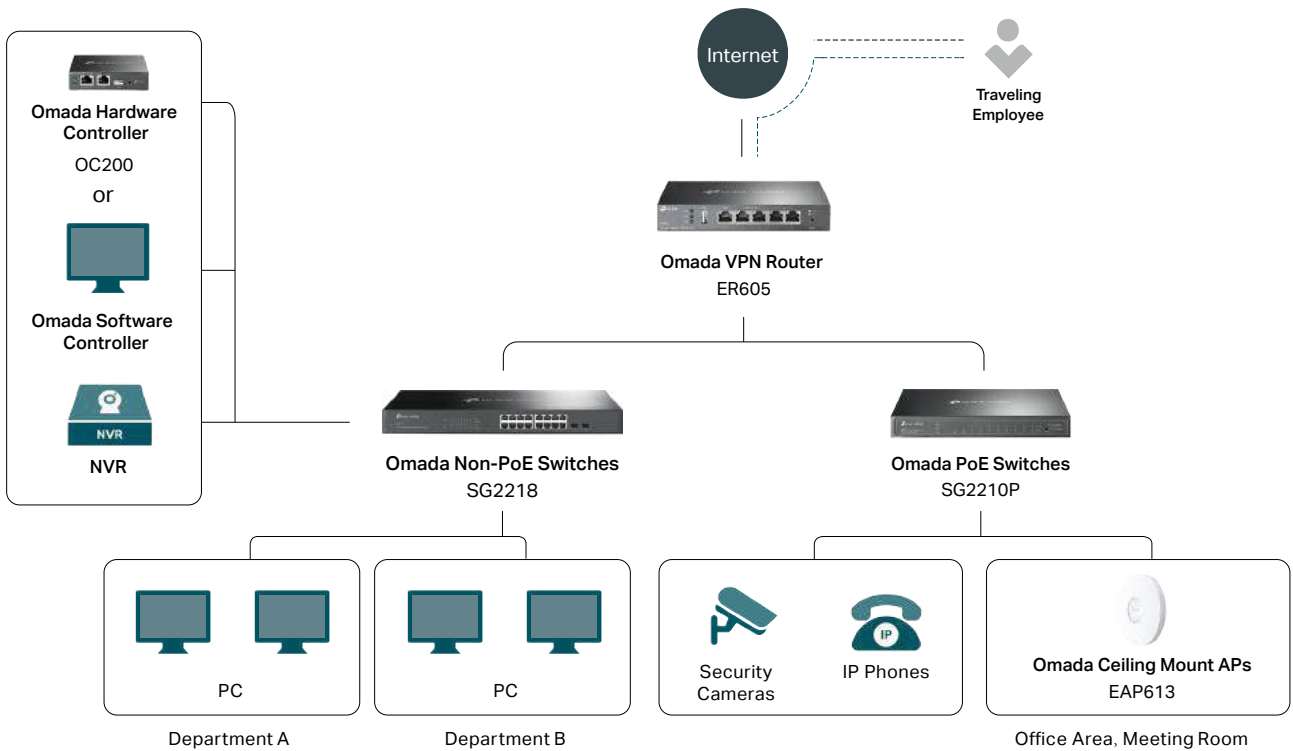

Small Offices (Less Than 50 Employees)			
Product	Model	Role	Features
Controllers	OC200	Management	Hardware Controller without running PCs; Manage up to <b>130 devices</b> ; Free cloud access; 802.3af/at PoE or Micro USB power supply
Routers	ER605	Gateway	<b>5× Gigabit</b> RJ45 ports; Up to <b>3 WAN</b> ports; Multi-WAN Load Balancing; Firewall; Enterprise-level Wireguard/IPSec/OpenVPN; LTE Backup with USB dongle
Switches	SG2210P	Connecting Access Points, IP Cameras, and IP Phones	<b>8× PoE+</b> Gigabit RJ45 ports; 2× Gigabit SFP ports; <b>61 W PoE</b> budget
	SG2218	Connecting PCs	<b>16× Gigabit</b> RJ45 ports; 2× Gigabit SFP ports
Ceiling Mount APs	EAP613	Office Areas and Meeting Rooms Wi-Fi	Wi-Fi 6; Up to <b>1.8 Gbps</b> Wi-Fi speed; 1× Gigabit RJ45 port; Mesh; Seamless roaming; Captive portal; 802.3at PoE power supply

## 2. Mid-Size Offices (50–250 Employees)

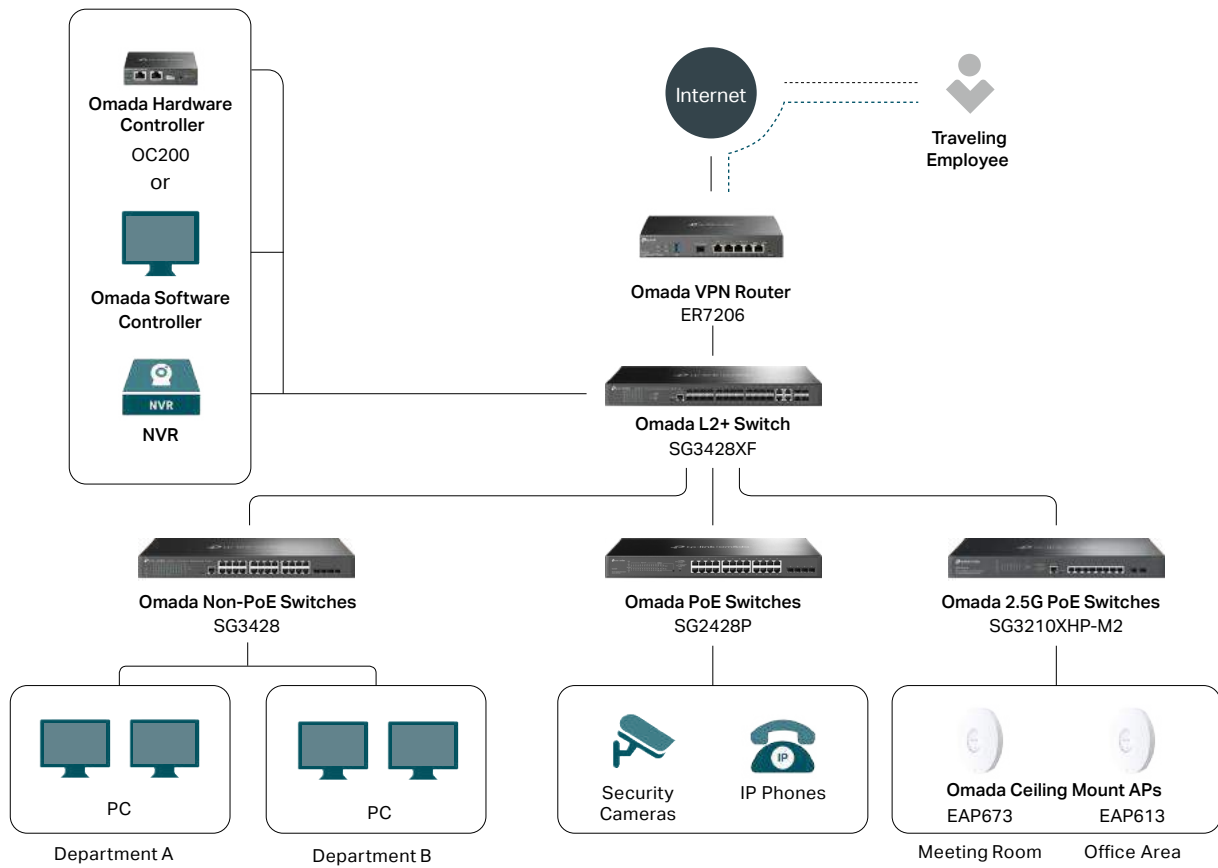

Mid-Size Offices (50–250 Employees)			
Product	Model	Role	Features
Controllers	OC200	Management	Hardware Controller without running PCs; Manage up to <b>130 devices</b> ; Free cloud access; 802.3af/at PoE or Micro USB power supply
Routers	ER7206	Gateway	<b>5× Gigabit</b> RJ45 ports + 1× Gigabit SFP ports; Up to <b>5 WAN</b> ports; Multi-WAN Load Balancing; Firewall; Enterprise-level SSL/ Wireguard/ IPsecVPN; LTE Backup with USB dongle
Switches	SG3428XF	Core Layer	<b>20× SFP</b> , 4× RJ45/SFP Combo Gigabit ports; <b>4× 10G SFP+</b> ports; Redundant power supplies
	SG3210XHP-M2	Connecting AP with 2.5G PoE Port	<b>8× 2.5G PoE+</b> RJ45 ports; <b>2× 10G SFP+</b> ports; <b>240 W PoE</b> budget
	SG2428P	Connecting IP Cameras and IP Phones	<b>24× PoE+</b> Gigabit RJ45 ports; 4× Gigabit SFP ports; <b>250 W PoE</b> budget
	SG3428	Connecting PCs	<b>24× Gigabit</b> RJ45 ports; 4× Gigabit SFP ports
Ceiling Mount APs	EAP673	Meeting Room Wi-Fi	Wi-Fi 6; Up to <b>5.4 Gbps</b> Wi-Fi speed; <b>1× 2.5G</b> RJ45 port; Mesh; Seamless roaming; Captive portal; 802.3at PoE power supply
	EAP613	Office Area Wi-Fi	Wi-Fi 6; Up to <b>1.8 Gbps</b> Wi-Fi speed; 1× Gigabit RJ45 port; Mesh; Seamless roaming; Captive portal; 802.3at PoE power supply

## Solution Benefits

### One-Stop Solution and Product Options

- ✓ From routers, switches, access points, controllers, to an end-to-end solution refresh
- ✓ Flexible controller options including Hardware, Software, and Cloud-Based Controllers

### Software-Defined Networking (SDN)

- ✓ Unified network management
- ✓ Zero-Touch Provisioning
- ✓ Multi-Customer and Multi-Site Management
- ✓ Customized user management permissions
- ✓ Network monitoring and integrated troubleshooting tools

### Reliable Performance and Enterprise Security

- ✓ Always-on Wi-Fi coverage
- ✓ Enterprise security functions including WPA3 and VPN
- ✓ Portal and 802.1X staff authentication
- ✓ Content filter and monitoring
- ✓ Load Balance and Loop Detection for robust network stability

## 1. EASY SETUP, SCALABILITY, AND MANAGEMENT TO FACILITATE BUSINESS

Omada's simplicity enables small and mid-size offices to easily set up and maintain their entire networks, even without professional full-time IT managers.



### Unified Network Management

Centrally manage access points, switches, and routers—all controlled from a single easy-to-use interface.



### Zero-Touch Provisioning

Enable plug-and-play deployment for new network equipment by creating configuration templates or using GUI-based menus to apply common settings.



### Flexible Management Architecture Increases Business Agility and Scalability

Omada offers hybrid cloud (on-premises) hardware and software controllers and Cloud-Based controllers to match enterprise networks of any size. The Omada Hardware Controller supports a centralized management scale of 130, 700, or 1300 devices. The software controller and Omada Cloud-Based Controller support an unlimited scale. Adding or adjusting devices is simple, increasing the agility and scalability of your business.



### Multi-Customer and Multi-Site Management

Manage multiple offices without switching controllers in Managed Service Provider (MSP) Mode. It's easier to check and manage multiple sites with a more well-organized management structure.



### Customized User Management Permissions

Multi-user privilege assignment is available to increase management efficiency and security. Multi-person management, multi-level permissions, and the ability to add admins as needed enable flexible network operation and maintenance.



### SNMP v2c/v3

Provides SNMP read and trap support for industry-standard Management Information Bases (MIB) and private extensions. LLDP facilitates easy mapping of network management applications.

## 2. RELIABLE PERFORMANCE MATTERS FOR COMPANY OPERATION

Fast connections and stability empower productivity for your business. The performance of the network must deliver an exceptional user experience. When entrepreneurs unify all network operations, it increases their ability to focus on business rather than on whether devices are connecting.



### Stable Wired Connections from Edge to Core

Omada offers enterprise routers, L2+ Managed, Smart, Easy Smart, and Unmanaged switches, catering to the demand for dependable networking from edge to core. Building high-speed wired connections and corporate backbone networks is simplified with Omada's 10G, 2.5G, and 1G Ethernet ports. The inclusion of 802.3bt/at/af PoE augments network deployment benefits. Business and employee offices depend significantly on consistent wired internet access, and Omada ensures a stable, fast wired connection as a top priority.



### Always-On Wi-Fi Coverage

Omada's Wi-Fi 7 and Wi-Fi 6 infrastructure is designed to support offices of any size with always-on, secure connectivity. Simultaneous connections to hundreds of devices without impacting Wi-Fi quality are supported. These ensure a smooth internet experience for daily office activities, like video meetings and large-file transfers and downloads, even in busy meeting rooms.





### Advanced Functions for Robust Network Stability and Performance

Supported by Multi-WAN routers, Load Balance, Storm Control, Loop Detection, Ethernet Ring Protection Switching (ERPS), LACP, QoS, Voice VLAN, and IPv6.



### Quick Troubleshooting for Minimized Interruption

Real-time network status, network monitoring, and integrated troubleshooting tools, such as PING, Traceroute, DNS QUERY, Terminal, and Packet Capture, allow for quick troubleshooting, even when the IT manager is away.



### AI Roaming for Uninterrupted Streaming

Ensures staff enjoy uninterrupted video and voice calling when moving around the office by switching clients automatically to the access points with the optimal signal. AI Roaming facilitates Fast Roaming and further optimizes the roaming experience.

## 3. NETWORK SECURITY SHOULD ALWAYS BE ASSURED

Cybersecurity is always the primary assurance when establishing an enterprise network. Company confidential information and privacy, business data, and employee information must be protected.



### Protects the Company Network from Threats

A robust firewall and advanced security functions protect networks and data. Attack Defense, high-security VPN, Access Control List (ACL), advanced WPA3 encryption, Captive Portal, 802.1X Authentication, MAC-Based Authentication, URL identification and filtering, MAC Filtering, IP-MAC-Port Binding, VLAN Binding, Port Security, and Guest Network are provided.



### VLAN to Divide Department Traffic

Assign VLANs to each department to segment staff traffic and enhance security. Policies are carried across the network end-to-end, regardless of the location of the user or device or the switch port carrying the traffic. Furthermore, Bridge VLAN saves up to 95% of the time for VLAN configuration when configuring 256 VLANs.



### Secure Networking with Authentication

Provide secure Wi-Fi access to authorized users (staff and authorized visitors) with multiple authentication options (802.1X/Radius/Local Database/TACACS+). Users and devices have restricted access to only network, IT, and application resources for which they have been approved. Optional Guest Network provides secure access to guests visiting the company.



### Two-Factor Authentication Enhances Account Security

Dramatically improves the security of your network management account and all the personal information you store with TP-Link.



### Know What's On the Network

Omada's easy-to-use dashboard lets you see your real-time network status and check network usage and traffic distribution. The network topology helps IT admins quickly see and troubleshoot connections at a glance.

## 4. MATCH YOUR BUSINESS WITH A FLEXIBLE NETWORK



### Work from Home with VPN Technology

Omada provides a secure and enterprise-standard VPN to allow staff to visit the office network even at home. The networks of each subsidiary can access the intranet of the Headquarters simultaneously.



### Online Behavior Moderation

Staff need to focus on business, not entertainment. Easily specify the internet access rights and strategies of employees via IP/MAC/URL Filtering and Access Control List (ACL).



### Flexible Criteria Management

Use different SSIDs, Access Control, and VLAN binding technologies to identify key network user profiles to deploy customized operating criteria. Configure clients with bandwidth management, device limits, and access permission to align with the company's strategy.

# Omada Solution for Restaurants

In the era of smart mobile devices, Wi-Fi has become a necessity for restaurants and cafes everywhere. Customers want to check out the news and send messages to friends, even while dining or lounging with a latte. When customers share their experiences online, businesses can also benefit from sharing promotional content and enhancing social media profiles. The TP-Link Omada solution empowers restaurant owners to create a modern and compelling in-store experience for every customer, while gaining acknowledgment from catering markets around the world.

## Typical Solution Topology and Product Recommendations

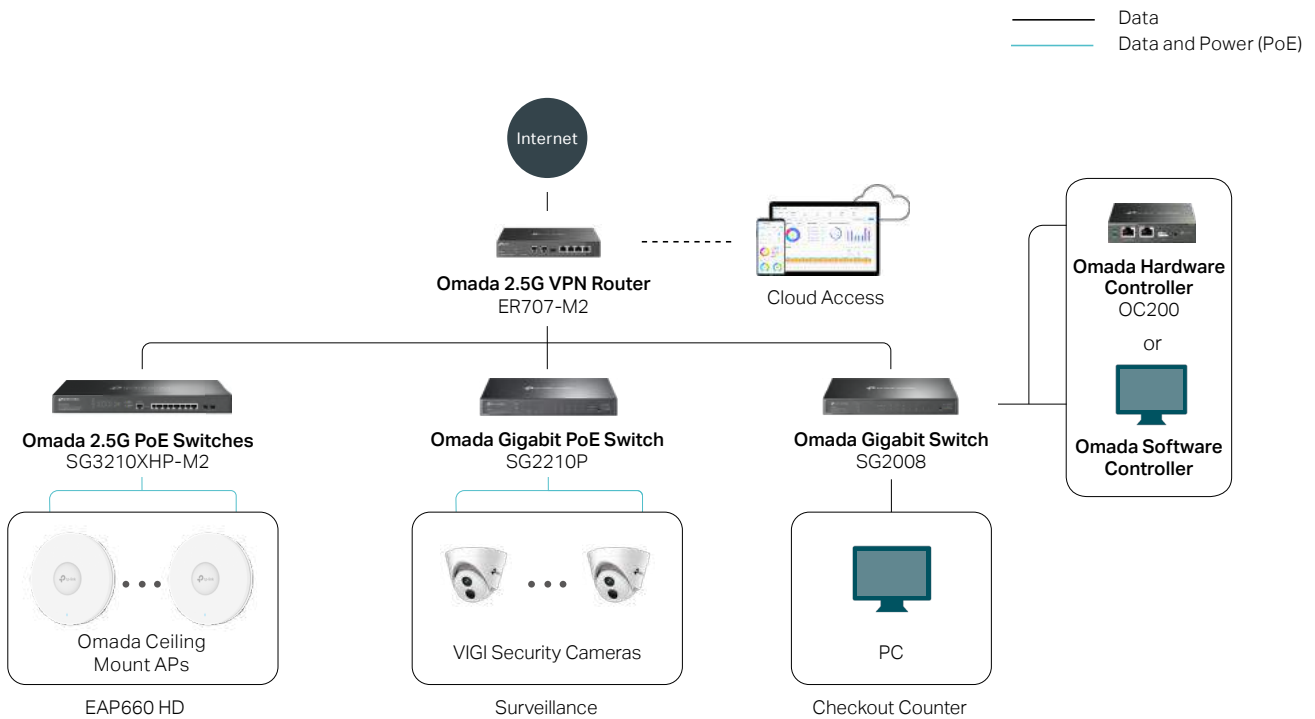

## Mid-Size Restaurants

Product	Model	Role	Features
Controllers	OC200	Management	Hardware Controller without running PCs; Manage up to <b>130 devices</b> ; Free cloud access; 802.3af/at PoE or Micro USB power supply
Routers	ER707-M2	Gateway	<b>2x 2.5G</b> RJ45 + 1x Gigabit SFP + 4x Gigabit RJ45 ports; Up to <b>6 WAN</b> ports; Multi-WAN Load Balancing; Firewall; Enterprise-level SSL/Wireguard/IPSecVPN; LTE Backup with USB dongle
Switches	SG3210XHP-M2	Connecting AP with 2.5G PoE Port	<b>8x 2.5G PoE+</b> RJ45 ports; <b>2x 10G SFP+</b> ports; <b>240 W PoE</b> budget
	SG2210P	Connecting IP Cameras, and IP Phones	<b>8x PoE+</b> Gigabit RJ45 ports; 2x Gigabit SFP ports; <b>61 W PoE</b> budget
	SG2008	Connecting PCs	<b>8x Gigabit</b> RJ45 ports
Ceiling Mount APs	EAP660 HD	Restaurant	Wi-Fi 6; Up to <b>3.6 Gbps</b> Wi-Fi speed; <b>1x 2.5G</b> RJ45 port; 4x4 MIMO antennas; Concurrent clients up to <b>1024</b> ; Mesh; Seamless roaming; Captive portal; 802.3at PoE / 12V DC power supply

## Small Restaurants

Product	Model	Role	Features
Controllers	OC200	Management	Hardware Controller without running PCs; Manage up to <b>130 devices</b> ; Free cloud access; 802.3af/at PoE or Micro USB power supply
Routers	ER605	Gateway	<b>5× Gigabit</b> RJ45 ports; Up to <b>3 WAN</b> ports; Multi-WAN Load Balancing; Firewall; Enterprise-level WireGuard/IPSec/OpenVPN; LTE Backup with USB dongle
Switches	SG2210P	Connecting IP Cameras, IP Phones, and PCs	<b>8× PoE+</b> Gigabit RJ45 ports; 2× Gigabit SFP ports; <b>61 W PoE</b> budget
Ceiling Mount Aps	EAP620 HD	Restaurant Wi-Fi	Wi-Fi 6; Up to <b>1.8 Gbps</b> Wi-Fi speed; 1× Gigabit RJ45 port; Concurrent clients up to <b>1024</b> ; Mesh; Seamless roaming; Captive portal; 802.3at PoE / 48V Passive PoE / 12V DC power supply

## Solution Benefits



### Boost Business with a Customized Page

Captive Portal provides direct exposure to promotional information and other marketing content while securing network access for guests.



### Stable Wi-Fi Coverage

Keeps your wireless online ordering system available everywhere with high-speed full Wi-Fi coverage.



### High-Density Wi-Fi Deployment

Omada Wi-Fi 6 and Wi-Fi 5 APs improve efficiency and ensure top-tier performance for your restaurant and café with high-density clients.



### Seamless Roaming for Uninterrupted Streaming

Ensure your customers enjoy uninterrupted streaming when moving around by switching clients automatically to the access points with the optimal signal.



### Streamline Insights with Network Monitoring

Access network performance and key customer metrics in real-time for improved business results, using a user-friendly dashboard.



### Easy Centralized Management

Centrally manage your access points, switches, routers, and more, anywhere, anytime—all controlled from a single easy-to-use interface.



### Stable High-Speed Wired Connections

2.5G or 1G Ethernet wired connections are provided for office computers, internet café computers, front desks, access points, and IP cameras.



### Easy Installation and Deployment

Easy mount construction; PoE support; and a refined, minimalist appearance allow for easy installation and deployment.

## TSUI WAH Restaurant

Scan for more info



**Name:** Tsui Wah Restaurant (Chain Restaurant)

**Capacity:** 30 restaurants

**Location:** Hong Kong, China

**Products:** 80× APs, 30× Switches

### Testimonial

"TP-Link's solution provides the same Wi-Fi performance at a much better price, which works within our budget much better. TP-Link helps us provide much better Wi-Fi than before. This improves our service substantially and our reputation among customers."

—Mr. Ben Leung, IT Engineer of the restaurant.



## Tang Palace Restaurant

Scan for more info



**Name:** Tang Palace Restaurant

**Capacity:** 600+ customers at peak time, 600+ square meters Wi-Fi coverage

**Location:** Dubai

**Products:** 9× APs, 1× Switch, 1× Router





# PoE Switches for Surveillance



# Omada PoE Switches for Surveillance

IP cameras are vital for business surveillance, offering critical visibility and insights. PoE (Power over Ethernet) switches are the go-to choice for modern surveillance needs. Omada offers a range of PoE switches tailored for IP cameras, with advanced features like Extend Mode, Priority Mode, and Isolation Mode. These go beyond basic connectivity, ensuring a flexible and dependable network that enhances business growth.

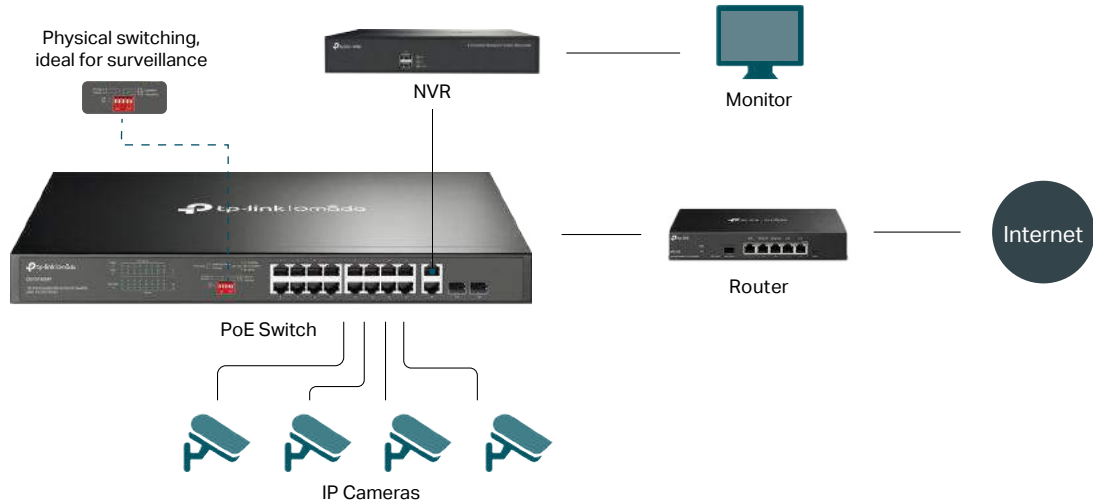

## Why Choose TP-Link Omada PoE Switches for Surveillance?



### 250 m PoE Transmission

With Extend Mode, PoE supports data and power transmissions up to 250 m (820 ft) away—perfect for surveillance camera deployment in large areas.<sup>1</sup>



### One-Click Traffic Separation

Isolation Mode easily divides traffic for downlink ports to avoid snooping and tampering and isolates broadcast storm for higher security and performance.



### Silent Operation

Fanless design reduces power consumption and ensures silent operation, ideal for noise-sensitive homes or businesses.<sup>5</sup>

<sup>5</sup>Certain products have fanless designs. Refer to the specification table for details.



### One-Click Priority Mode

Guarantees the quality of sensitive applications like video monitoring in critical business areas by prioritizing the data of certain ports.



### PoE Auto Recovery for Cameras

Automatically detects and reboots dropped or unresponsive PoE-powered devices to reduce the possibility of downtime. It also saves maintenance costs by eliminating manual monitoring and rebooting—vital for hard-to-reach devices.



### Flexible Product and Management Options

Omada offers a variety of Managed and Unmanaged PoE switches with Fast Ethernet or Gigabit ports.<sup>5</sup> The Managed PoE switches are integrated into the Omada SDN system for 100% centralized cloud management.

<sup>5</sup>Omada Unmanaged Switches are Plug and Play compatible and do not support Omada SDN central management.



# Omada Unmanaged PoE Switches for Surveillance



250 m (820 ft) PoE Transmission†



Port Prioritization



One-Click Traffic Separation



PoE Auto Recovery



Silent Operation



Plug and Play



## DS105GP

Omada 5-Port Gigabit Desktop Switch with 4-Port PoE+

- 4× Gigabit PoE+ Ports
- Supports 802.3af/at
- 65 W PoE Budget
- Up to 250 m (820 ft) PoE†
- PoE Auto Recovery
- Desktop / Wall Mounting



## DS110GMP

Omada 10-Port Gigabit Desktop Switch with 8-Port PoE+

- 8× Gigabit PoE+ Ports
- Supports 802.3af/at
- 123 W PoE Budget
- Up to 250 m (820 ft) PoE†
- PoE Auto Recovery
- One-Click Traffic Separation
- Desktop / Wall Mounting

	GE					FE	
Model	DS1018GMP	DS110GMP	DS108GP	DS106GPP	DS105GP	DS111P	DS106P
PoE Ports	16× GE PoE+	8× GE PoE+	8× GE PoE+	1× GE PoE++ 3× GE PoE+	4× GE PoE+	8× 10/100 Mbps PoE+	4× 10/100 Mbps PoE+
Non-PoE Ports	2× GE SFP/RJ45 Combo	1× Gigabit RJ45, 1× Gigabit Combo (SFP/RJ45)	-	2× GE	1× GE	2× GE, 1× SFP	2× 10/100 Mbps
PoE Standards	802.3af/at	802.3af/at	802.3af/at	802.3af/at/bt type 3 (Port 1) 802.3af/at (Ports 2-4)	802.3af/at	802.3af/at	802.3af/at
PoE Budget	250 W	123 W	65 W	64 W	65 W	65 W	67 W
Priority Mode	Ports 1-4	Ports 1-2	-	-	-	-	Ports 1-2
Extend Mode	Ports 1-4	Ports 1-4	Ports 1-2	Ports 1-2	Ports 1-2	Ports 1-4/1-8	Ports 1-4
Isolation Mode	Ports 1-8/9-16	Ports 1-4/5-8	-	-	-	Ports 1-8	-
PoE Auto Recovery	Ports 1-16	Ports 1-8	Ports 1-8	Ports 1-4	Ports 1-4	Ports 1-8	Ports 1-4
Installation	19-inch Rackmount	Desktop / Wall Mounting					
Fanless for Silent Operation	-	✓	✓	✓	✓	✓	✓
Green Tech	✓	✓	✓	✓	✓	✓	✓
802.1p/DSCP QoS	✓	✓	✓	✓	✓	-	-
IGMP Snooping	-	✓	✓	✓	✓	-	-

# Omada Managed PoE Switches for Surveillance



Cloud Centralized Management\*\*



Zero-Touch Provisioning\*



Easy Network Monitoring



Multi-Site Management\*\*



Omada App\*\*



PoE Auto Recovery



- 5× Gigabit Ports (1-Port PoE++ in, 4-Port PoE+ out)
- Max 64 W PoE Budget
- Up to 200 m (656 ft) PoE Distance without Losing Gigabit Speeds
- IP55 Weatherproof



- 8× Gigabit PoE+ Ports
- Supports 802.3af/at
- 61 W PoE Budget
- PoE Auto Recovery
- 2× Gigabit SFP Slots
- Desktop / Wall Mounting

## SG2005P-PD

Omada Gigabit Smart Switch with 1-Port PoE++ In and 4-Port PoE+ Out

## SG2210P

Omada 10-Port Gigabit Smart Switch with 8-Port PoE+

Model	Easy Managed Switch (GE Ports)		Smart Switch (FE Ports)	Smart Switch (GE Ports)							L2+ Switch (GE Ports)	
	ES205GP	ES210GP	SL2428P	SG2005P-PD	SG2008P	SG2210P	SG2210MP	SG2016P	SG2218P	SG2428P	SG3428MP	SG3452P
<b>PoE+ Ports</b>	4× GE	8× GE	24× FE	4× GE	4× GE	8× GE	8× GE	8× GE	16× GE	24× GE	24× GE	48× GE
<b>Non-PoE Ports</b>	1× GE	1× GE, 1× Gigabit Combo	2× GE, 2× Gigabit Combo	1× GE (PoE++ in)	4× GE	2× SFP	2× SFP	8× GE	2× SFP	4× SFP	4× SFP	4× SFP
<b>PoE Standards</b>	802.3at/af	802.3at/af	802.3at/af	PoE in: 802.3bt/at/af PoE out: 802.3af/at	802.3at/af	802.3at/af	802.3at/af	802.3at/af	802.3at/af	802.3at/af	802.3at/af	802.3at/af
<b>PoE Budget</b>	63 W (TBD)	120 W (TBD)	250 W	Up to 64 W	62 W	61 W	150 W	120 W	150 W	250 W	384 W	384 W
<b>PoE Auto Recovery</b>	√	√	√	√	√	√	√	√	√	√	√	√
<b>Installation</b>	Desktop / Wall Mounting	Desktop / Wall Mounting	19-inch Rackmount	Wall/Pole Mounting	Desktop / Wall Mounting	Desktop / Wall Mounting	13-inch Rackmount / Desktop	Desktop / Wall Mounting	19-inch Rackmount	19-inch Rackmount	19-inch Rackmount	19-inch Rackmount
<b>Fanless for Silent Operation</b>	√	√	-	√	√	√	-	√	-	-	-	-
<b>IP Rating</b>	-	-	-	IP55 for Outdoor Use	-	-	-	-	-	-	-	-
<b>Software Functions</b>	802.1Q VLAN, Port/802.1p/DSCP QoS		Static Routing, 802.1Q VLAN, Voice VLAN, 802.1p/DSCP QoS, LLDP-MED, STP/RSTP, IGMP Snooping, ACL, SNMP, DHCP Server, IGMP Snooping, Centralized Management, Standalone Mode									



Discover More about TP-Link PoE Switches

<sup>1</sup>The speed of the ports in Extend Mode will be downgraded to 10 Mbps. Actual transmission distance may vary due to cable quality.

<sup>2</sup>PoE budget calculations are based on laboratory testing. Actual PoE power budget is not guaranteed and will vary as a result of client limitations and environmental factors.

<sup>3</sup>Not all PoE switches support this feature. Please refer to the comparison table for details.

<sup>4</sup>Zero-Touch Provisioning requires the use of the Omada Cloud-Based Controller.

Please go to [www.tp-link.com/omada-cloud-based-controller/product-list](http://www.tp-link.com/omada-cloud-based-controller/product-list) to confirm which models are compatible with the Omada Cloud-Based Controller.

<sup>5</sup>These functions require the use of Omada Controllers.

# Long-Range Networking for Surveillance

Wireless PtMP and PtP links provide a perfect wireless surveillance solution for remote storehouses, construction sites, mining sites, logging sites, and more. Omada Long-Range Outdoor Access Points, an important member of Omada Software-Defined Networking (SDN), provide PtMP and PtP links and are ideal for hundreds of meters to multi-kilometer long-distance wireless data transmissions, saving wiring costs for your network.

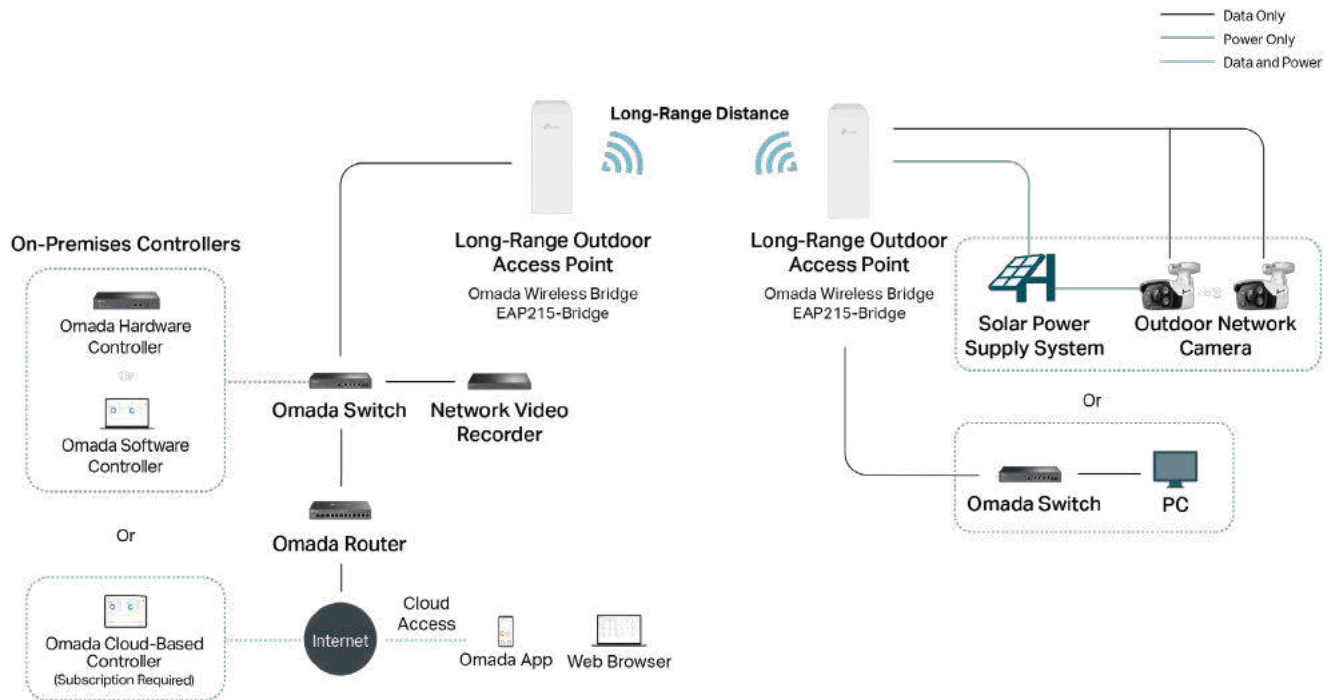

Recommended Scenarios	Multiple 2K+ cameras in remote locations	Multiple 2K+ cameras in remote locations within 1 km	Multiple HD cameras in remote locations
Product Images			
Model	EAP215-Bridge KIT	EAP211-Bridge KIT	EAP115-Bridge KIT
Frequency		5 GHz	
Max Wireless Speed*	867 Mbps	867 Mbps	300 Mbps
Max Transmission Distance*	5 km+	1 km+	5 km+
Weatherproof Enclosure		IP65	
Lightning Protection		6 kV	
Ethernet Ports	3x Gigabit	3x Gigabit	3x 10/100 Mbps
Power Supply Method	Passive PoE and 12 VDC		
Centralized Management	Omada; Cloud Access; Omada App		
Operating Temperature	-40°~70° (-40°~158°)		

\*Maximum wireless signal rates are the physical rates derived from IEEE Standard 802.11 specifications. The max ranges of products are tested in real outdoor environments. Actual range and throughput are not guaranteed and will vary as a result of network conditions, and depend on the transmission power and environmental factors such as wireless interference, obstacles, weather, etc.



### Centralized Multi-Site Management

Control the whole network in multiple sites on a single interface from anywhere with the Omada SDN platform. Cut down on your maintenance costs and vastly improve your network efficiency.



### Auto-Pairing

Automatically establishes a network when a gateway is configured and access points are powered on, avoiding complex setups.



### Waterproof & Dustproof & 6kV Lightning Protection

An IP65-rated waterproof and dustproof case with 6kV lightning protection fully protects your network data from prolonged exposure outdoors.



### Three Gigabit/FE Ports for Multiple Cameras

Provide wired connections to more IP cameras, easing the burden of complex device deployment.



### Up to 5 km Transmission Distance (Varies by Model)

Eliminates the limitations of traditional cable transmission distance. Ideal for multi-kilometer long-distance wireless data transmissions, saving wiring costs for your network.



### Agile LEDs for Quick Deployment

Flexibly adjust your wireless bridges' position and angle following the LED signal strength displays for optimal reception after auto-pairing.



### Flexible DC + Passive PoE Power Supply

Supports both 12V DC and Passive PoE for versatile deployment. Compatibility with TP-Link Solar Power Supply also adds an eco-friendly and flexible energy option.



### Stable Long-Range Video Transmission

Enjoy seamless and sharp video monitoring with Wi-Fi speeds up to 867 Mbps. Omada's wireless bridge products facilitate HD video relay from distant cameras, featuring robust long-range transmission capabilities.

# Wireless Networking for Elevators

For any business in a multi-story building, ensuring elevators are connected to the network can be critical for applications like video surveillance and digital signage. Traditionally, solutions like high-tension Ethernet cables—running from either the top or bottom of the elevator shafts—are used to accomplish this. But this method has some significant drawbacks: Construction must allow for these cables; installation is more intensive; and eventually, the cabling will break due to normal wear and tear. To mitigate these issues, TP-Link Omada offers a solution: a wireless point-to-point link delivering throughput up to 867 Mbps. Wireless coverage extends to the entire shaft to connect surveillance cameras or digital signage directly to your network. Record real-time video to an NVR with virtually no hard wiring required, leaving no cables to wear out.

## Typical Solution Topology

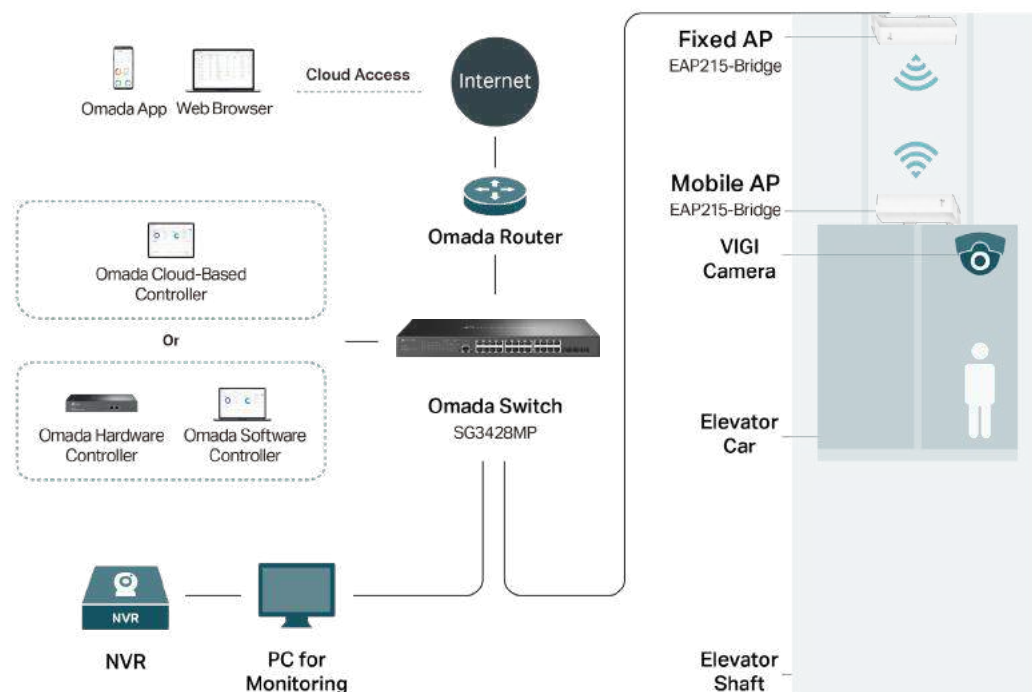

## Product Recommendations

2K+ Camera Surveillance Solutions						
Models	Frequency	Max Wi-Fi Speeds*	Ethernet Ports	Power Supply	Max Range*	
EAP215-Bridge KIT	5 GHz	867 Mbps	3× 1G	Passive PoE or DC	5 km+	

HD Camera Surveillance Solutions						
Models	Frequency	Max Wi-Fi Speeds*	Ethernet Ports	Power Supply	Max Range*	
EAP115-Bridge KIT	5 GHz	300 Mbps	3× FE	Passive PoE or DC	5 km+	

\*Maximum wireless signal rates are the physical rates derived from IEEE Standard 802.11 specifications. The max ranges of products are tested in real outdoor environments. Actual range and throughput are not guaranteed and will vary as a result of network conditions, and depend on the transmission power and environmental factors such as wireless interference, obstacles, weather, etc.



## 1. COST-SAVING WIRELESS TRANSMISSION WITH EASY SETUP AND INSTALLATION



### Easy, Flexible Installation

Eliminate the limitations of traditional cable transmission distance and the construction requirements for cable deployment in elevator shafts.



### No Complex Cabling

Wireless transmission ensures cable wear and tear is no longer a concern. Physical deployment costs are reduced due to fewer required physical installations as well as reduced construction costs.



### Auto-Pairing

Automatically establishes a network when a gateway is configured and access points are powered on, avoiding complex setups.



### Agile LEDs for Quick Deployment

Flexibly adjust your wireless bridges' position and angle following the LED signal strength displays for optimal reception after auto-pairing.



### Flexible DC and Passive PoE Power Supply

Passive Power over Ethernet support allows for flexible deployment and convenient installation.



### Reliable Quality with Low Maintenance

TP-Link's high product quality ensures maintaining your wireless elevator system is as easy as possible.

## 2. EASY MANAGEMENT SIMPLIFIES OPERATION



### Unified Network Management

Centrally manage access points, switches, and routers—all controlled from a single easy-to-use interface.



### Multi-Customer and Multi-Site Management

Under Managed Service Provider (MSP) Mode, oversee multiple building sites seamlessly without toggling between controllers. This mode simplifies the monitoring and management of various locations with a streamlined and structured approach.



### Customized User Management Permissions

Multi-user privilege assignment is available to increase management efficiency and security. Multi-person management, multi-level permissions, and the ability to add admins as needed enable flexible network operation and maintenance.

## 3. HIGH-SPEED AND STABLE WIRELESS CONNECTIONS TO MEET THE NEEDS OF ELEVATOR MONITORING



### Wi-Fi Speeds Up to 867 Mbps

Ensure video monitoring and other data-intensive functions remain optimal.



### Stable Connections at High Speeds

Real-world use has proven that Omada wireless bridge products deliver stable transmissions and smooth video even when elevators rapidly run between floors.



### Long-Range Video Transmission

TP-Link Omada wireless bridge products easily relay HD video from elevator surveillance cameras thanks to extensive features that ensure robust long-range transmission.



### Weatherproof for Elevator Use

IP65-rated waterproof and dustproof casing fully protects your network data from prolonged exposure in elevator shafts.

# Omada Business Wi-Fi for Warehouses

With the increasing prevalence of Wi-Fi-supported devices, smart devices, and mobile internet applications, warehouses are relying on Wi-Fi technology now more than ever. However, there are some difficulties that make warehouses difficult locations for Wi-Fi: large spaces, full of obstacles, fluctuating user densities, and constantly changing inventory. A reliable and high-performance Wi-Fi network is essential for the functioning of business terminals (handhelds, tablets, etc.) to communicate with software such as Enterprise Resource Planning (ERP) and Warehouse Management Systems (WMS).

Omada business Wi-Fi, an important part of the Omada Software-Defined Networking (SDN) solution, provides one-stop access to high-quality services and high-performance products, ideal for deploying high-quality Wi-Fi in warehouses.

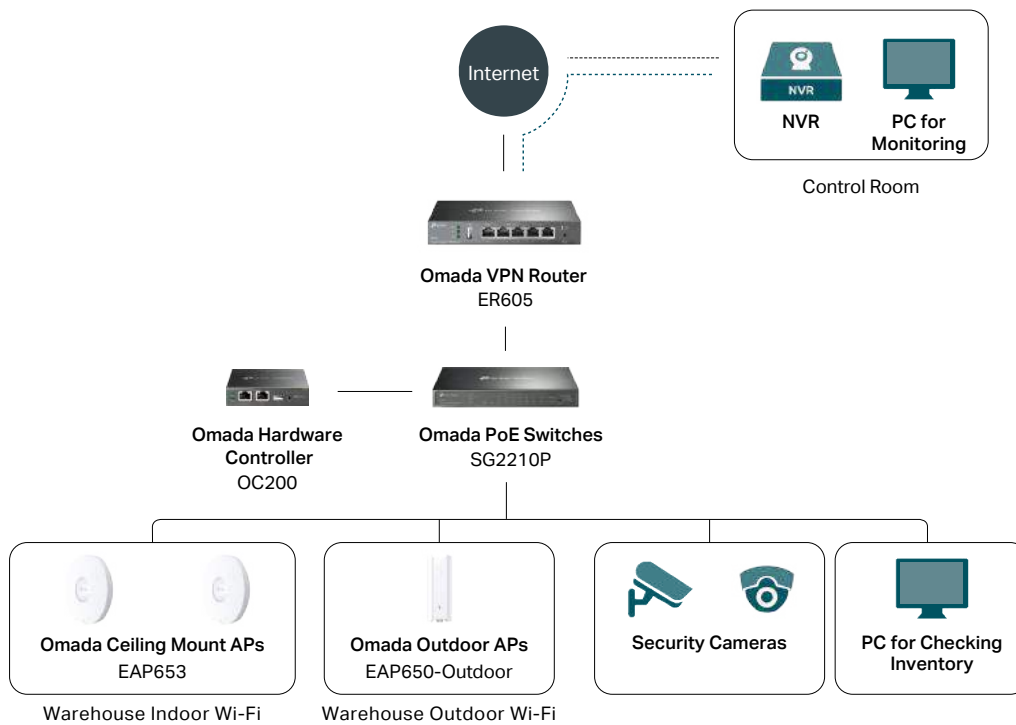

Warehouse Wi-Fi Solution			
Product	Model	Role	Features
Controllers	OC200	Management	Hardware Controller without running PCs; Manage up to <b>130 devices</b> ; Free cloud access; 802.3af/at PoE or Micro USB power supply
Routers	ER605	Gateway	<b>5× Gigabit</b> RJ45 ports; Up to <b>3 WAN</b> ports; Multi-WAN Load Balancing; Firewall; Enterprise-level WireGuard/IPSec/OpenVPN; LTE Backup with USB dongle
Switches	SG2210P	Connecting Access Points, IP Cameras, and PC	<b>8× PoE+</b> Gigabit RJ45 ports; 2× Gigabit SFP ports; <b>61 W PoE</b> budget
Ceiling Mount APs	EAP653	Warehouse Indoor Wi-Fi	Wi-Fi 6; Up to <b>3.0 Gbps</b> Wi-Fi speed; 1× Gigabit RJ45 port; Mesh; Seamless roaming; 802.3at PoE/48V Passive PoE power supply
Outdoor APs	EAP650-Outdoor	Warehouse Outdoor Wi-Fi	Wi-Fi 6; Up to <b>3.0 Gbps</b> Wi-Fi speed; 1× Gigabit RJ45 port; Mesh; Seamless roaming; <b>IP67</b> weatherproof; 802.3at PoE/48V Passive PoE power supply

# What Omada Offers

## One-Stop Solution and Product Options

- ✓ From routers, switches, access points, controllers, to an end-to-end solution refresh
- ✓ Flexible controller options including Hardware, Software, and Cloud-Based Controllers

## Software-Defined Networking (SDN)

- ✓ Unified network management
- ✓ Zero-Touch Provisioning
- ✓ Wi-Fi Heatmap Simulator
- ✓ Multi-Customer and Multi-Site Management
- ✓ Customized user management permissions
- ✓ Integrated troubleshooting tools
- ✓ Real-time network status and full report of clients, devices, and Wi-Fi

## Reliable Wi-Fi Performance for Warehouses

- ✓ Always-on Wi-Fi coverage
- ✓ Auto Channel Selection and Power Adjustment to automatically maintain the optimized Wi-Fi
- ✓ Mesh and Seamless Roaming
- ✓ Target Wake Time (TWT) improves battery life for mobile and IoT devices.

## 1. EASY SETUP AND MANAGEMENT TO FACILITATE BUSINESS



### Unified Network Management

Centrally manage access points, switches, and routers—all controlled from a single easy-to-use interface.



### Zero-Touch Provisioning

Allows admins to remotely deploy and configure multi-site networks, so there's no need to send out an engineer for on-site configuration.



### Flexible Management Architecture Increases Business Agility and Scalability

Omada offers hybrid cloud (on-premises) hardware and software controllers and Cloud-Based controllers to match enterprise networks of any size.



### Multi-Customer and Multi-Site Management

Manage multiple warehouses without switching controllers in Managed Service Provider (MSP) Mode.



### Customized User Management Permissions

Multi-user privilege assignment, Multi-person management, multi-level permissions, and the ability to add admins as needed increase management efficiency and security.



### Wi-Fi Heatmap Simulator

Generate a Wi-Fi solution by simulating the wireless coverage effect of APs in the actual warehouse.

## 2. RELIABLE PERFORMANCE MATTERS FOR WAREHOUSE OPERATION



### Always-On Wi-Fi Coverage

Omada's Wi-Fi 7 and Wi-Fi 6 infrastructure is designed to support warehouses of any size with always-on, secure connectivity by steering around obstacles. High-power amplified antennas and Beamforming combine to ensure Wi-Fi coverage for large surface areas of warehouses.



### Auto Channel Selection and Power Adjustment

Provides powerful wireless performance while greatly reducing Wi-Fi interference by automatically adjusting the channel settings and transmission power levels of neighboring APs in the same network.



### AI Roaming for Uninterrupted Streaming

Ensures mobile devices enjoy uninterrupted connections when moving around the warehouse by switching clients automatically to the access points with the optimal signal.



### Quick Troubleshooting for Minimized Interruption

Real-time network status, network monitoring, and integrated troubleshooting tools, such as PING, Traceroute, DNS QUERY, Terminal, and Packet Capture, allow for quick troubleshooting, even when the IT manager is away.



### Prolongs the Battery Life of Mobile and IoT Devices

Target Wake Time (TWT) allows devices to negotiate when and how often they will wake up to send or receive data, increasing device sleep time and substantially improving battery life for mobile and IoT devices.



### Mesh Wi-Fi, PoE, and Wall-Mount Support for Flexible Installation and Deployment

Omada's versatile ceiling mount access points are also wall-mountable, while outdoor units accommodate both wall and pole mounting. This flexibility addresses the challenge of high-ceilinged warehouses, guaranteeing comprehensive Wi-Fi coverage.



### Robust Network Stability and Performance

Supports Multi-WAN routers, Load Balance, Storm Control, Loop Detection, Ethernet Ring Protection Switching (ERPS), LACP, QoS, Voice VLAN, and IPv6.



### Real-time Network Status and Full Report of Clients, Devices, WAN, and Wi-Fi

Monitor real-time network status and various kinds of information at a glance. Easily check the details of faulty devices in the system topology.

# Professional Wi-Fi for High-Density Environments

High-density Wi-Fi environments are locations with hundreds or even thousands of Wi-Fi clients. Common cases are meeting rooms, restaurants, shopping malls, outdoor events, and playgrounds. High-density Wi-Fi solutions will remain an important part of enterprise network upgrading for years to come. Omada access points, an important part of the Omada Software-Defined Networking solution, provide a range of capable indoor and outdoor solutions designed to meet the increasing demands of high-density networks.

## Typical Solution Topology and Product Recommendations

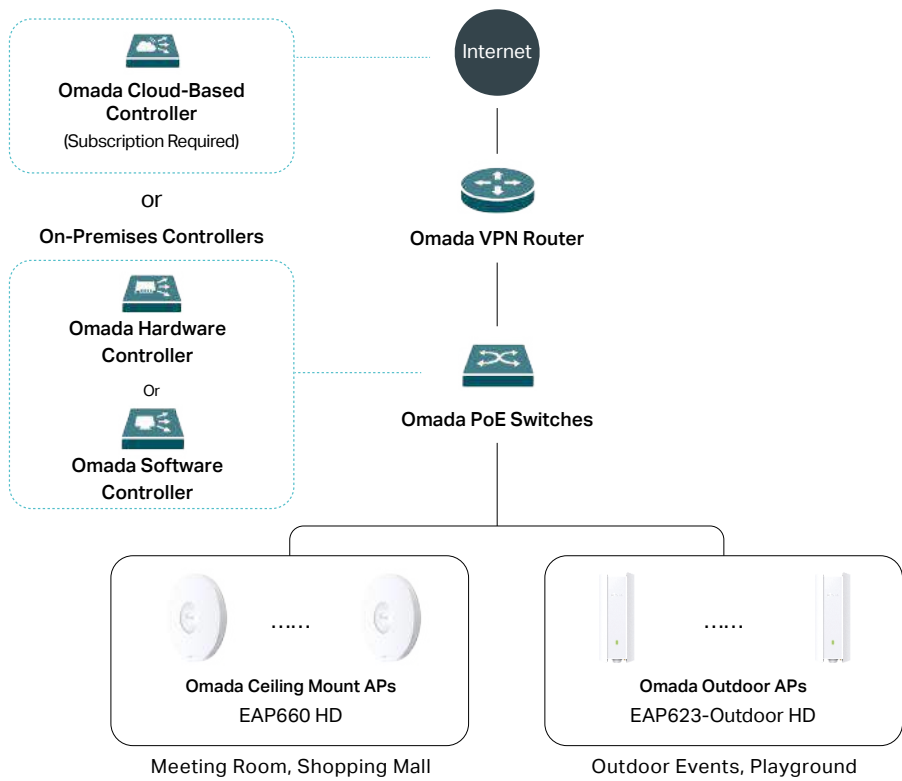

Type	Model	Wi-Fi Class	Ethernet Ports	Concurrent Clients	Main Features
Indoor	EAP660 HD	AX3600	1× 2.5G	1024	Wi-Fi 6; Up to <b>3.6 Gbps</b> Wi-Fi speed; <b>1× 2.5G</b> RJ45 port; 4×4 MIMO antennas; Concurrent clients up to <b>1024</b> ; Mesh; Seamless roaming; Captive portal; 802.3at PoE / 12V DC power supply
Outdoor	EAP623-Outdoor HD	AX1800	1× 1G	1024	Wi-Fi 6; Up to <b>1.8 Gbps</b> Wi-Fi speed; 1× Gigabit RJ45 port; Mesh; Seamless roaming; Captive portal; <b>IP67</b> weatherproof; 802.3at PoE / 48V Passive PoE power supply



### Larger Capacity for High-Density Environments

Omada high-density access points improve efficiency and ensure top-tier performance for high-density locations like shopping malls, supermarkets, and restaurants. Actual testing proves that high-end Wi-Fi 6 High-Density (HD) APs can connect over two hundred clients at the same time. In reality, the maximum recommended client density depends on environmental conditions.

\*Testing was conducted in the TP-Link laboratory with clients running different applications. The actual maximum client density depends on environmental conditions.

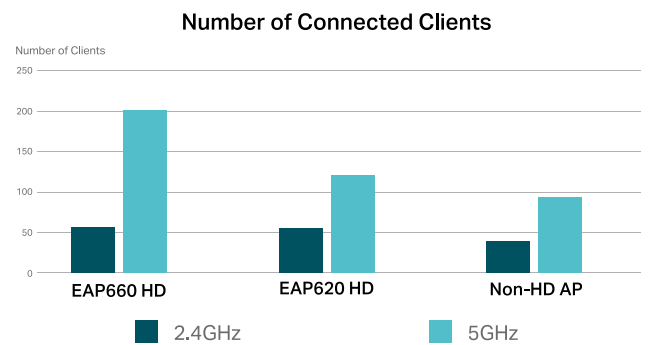

### Centralized Multi-Site Management

Control the whole network in multiple sites on a single interface from anywhere with the Omada SDN platform. Cut down on your maintenance costs and vastly improve your network efficiency.

### Easy Installation and Deployment

Featuring straightforward mounting and a clean, modern design, our PoE-compatible devices ensure a versatile and effortless installation process.

### Auto Channel Selection and Transmission Power Adjustment

To prevent overlapping channel interference, the AP automatically adjusts the radio frequencies to avoid co-channel interference and increase efficiency.

### Load Balance

Balances the number of users across APs to ensure the highest possible performance for all users.

### Airtime Fairness

ATF increases efficiency and capacity across the network by preventing older devices from interfering with peak usage periods.

### Boost Business with a Customized Page

Captive Portal provides direct exposure to promotional information and other marketing content while securing network access for guests.

### Omada Mesh Technology

Omada Mesh enables wireless connectivity between access points for extended range, making wireless deployment more flexible and convenient.

### Seamless Roaming

Ensures customers enjoy uninterrupted streaming when moving around by switching automatically to the access points with the optimal signal.



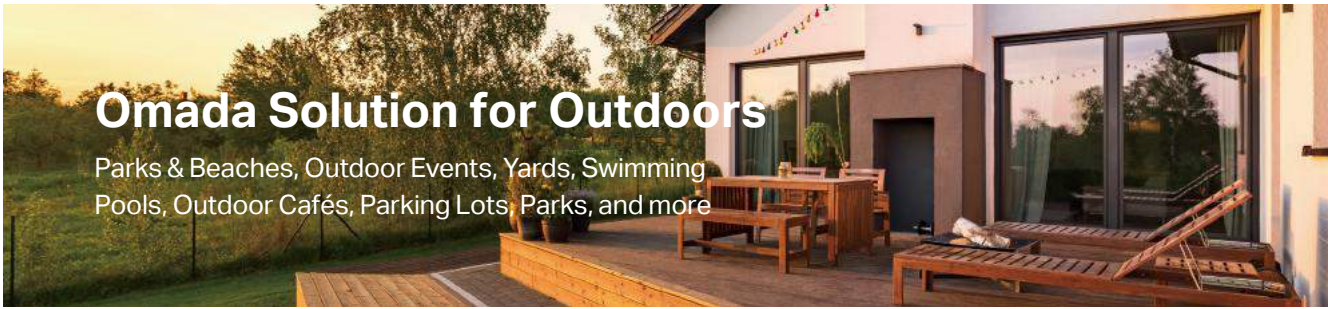

Wi-Fi is essential outdoors, for events like parties, work in the garden, or connecting devices such as outdoor cameras and speakers. Omada outdoor Wi-Fi access points ensure a reliable connection, even in tough weather conditions. Perfect for outdoor gatherings, home gardens, yards, pools, cafes, barns, and sheds, our extenders provide a seamless outdoor Wi-Fi experience.

## Typical Solution Topology and Product Recommendations

### 1. Near Site with a Small Outdoor Area

Outdoor Wi-Fi for Yards/Gardens/Home Swimming Pools/Sheds/Barns/and More

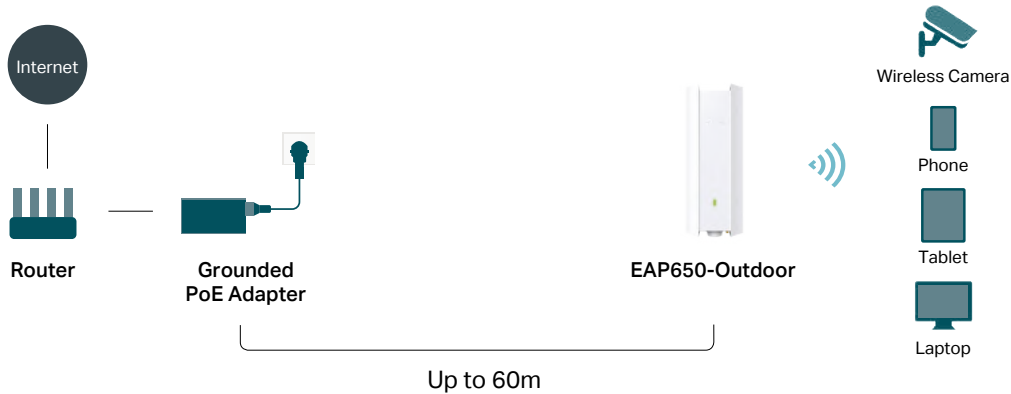

Type	Model	Wi-Fi Class	Ethernet Ports	Max Wireless Range*	Main Features
Outdoor	EAP650-Outdoor	AX3000	1x Gigabit	<ul style="list-style-type: none"> <li>•2.4GHz: 200m+</li> <li>•5GHz: 300m+</li> </ul>	Wi-Fi 6; Up to <b>3.0 Gbps</b> Wi-Fi speed; 1x Gigabit RJ45 port; Mesh; Seamless roaming; Captive portal; <b>IP67</b> weatherproof; 802.3at PoE /48V Passive PoE power supply

\*Based on field tests. The real transmission range may vary, according to the environment, receiving device, etc.

### 2. Near Site with a Medium to Large Outdoor Area

Outdoor Wi-Fi for Outdoor Events/Medium and Big Outdoor Swimming Pools/Outdoor Cafés/Parking Lots/Parks/Amusement Parks/Outdoor Amphitheatres/and More

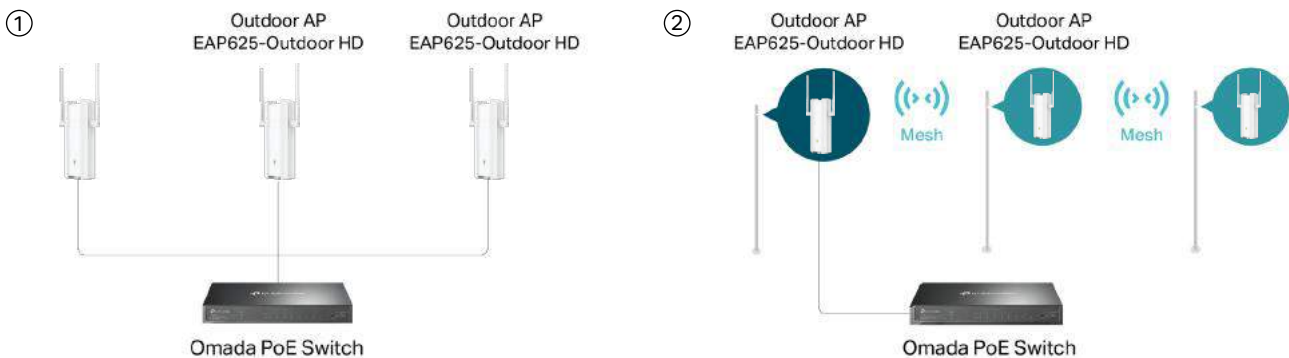

Type	Model	Wi-Fi Class	Ethernet Ports	Max Wireless Range*	Main Features
Outdoor	EAP625-Outdoor HD	AX1800	1× Gigabit	<ul style="list-style-type: none"> <li>• 2.4 GHz: 200m+</li> <li>• 5 GHz: 300m+</li> </ul>	Wi-Fi 6; Up to <b>1.8 Gbps</b> Wi-Fi speed; Long range with external antennas 1× Gigabit RJ45 port; Mesh; Seamless roaming; Captive portal; <b>IP67</b> weatherproof; 802.3at PoE /48V Passive PoE power supply

\*Based on field tests. The real transmission range may vary, according to the environment, receiving device, etc.

### 3. Remote Site (More than 100 meters and up to 5 km)

Remote Cameras/RV Parks/Highway Billboards/Construction Sites/and More

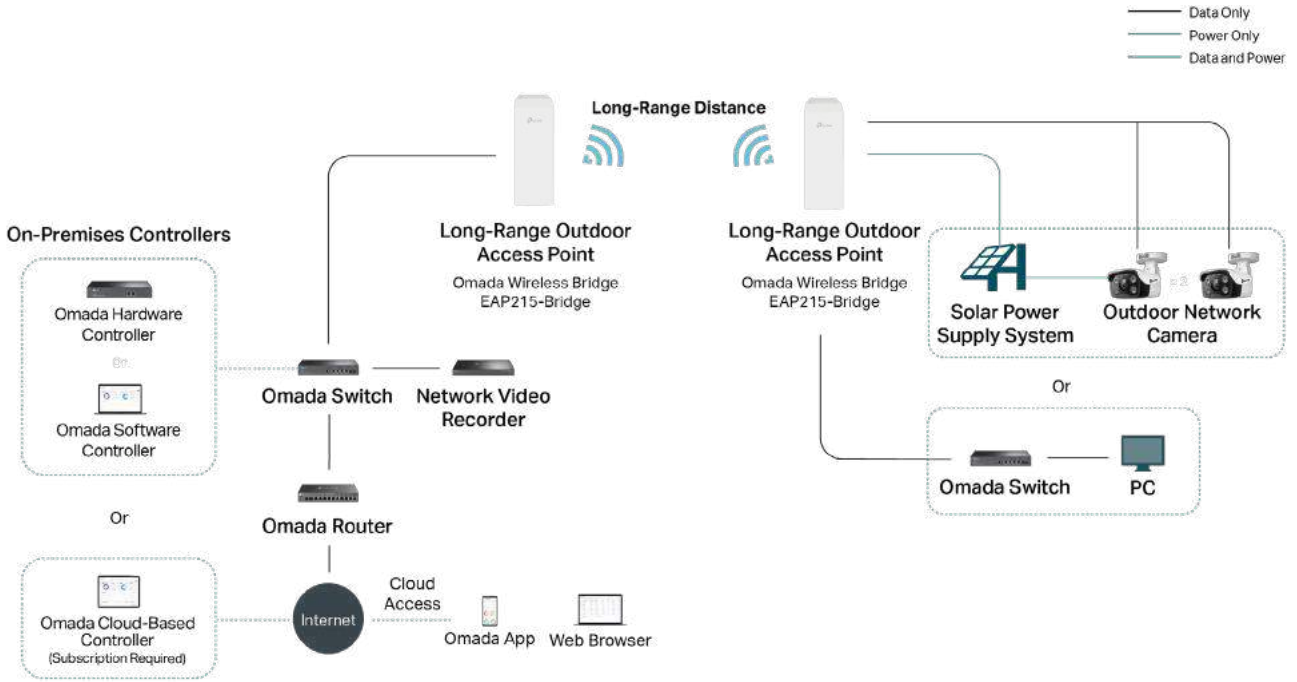





Type	Model	Wi-Fi Class	Ethernet Ports	Max Wireless Range*	Main Features
Outdoor	EAP215-Bridge KIT	AC867	3× Gigabit	• 5 km+	Up to <b>867 Mbps</b> Wi-Fi speed; <b>3× Gigabit</b> RJ45 port; <b>IP65</b> weatherproof; 6 kV lightning protection; Passive PoE and DC power supply; <b>Auto-Pairing</b> ; Agile LEDs for quick deployment

\*Based on field tests. The real transmission range may vary, according to the environment, receiving device, etc.

# Product Specifications



## Omada Controllers

Model		On-Premises Controller				Omada Cloud-Based Controller	
		Omada Hardware Controller			Omada Software Controller		
		OC200	OC300	OC400			
Product Picture							
Main Design	Usage Method	Connect to the intranet			Deploy to intranet servers or private clouds	Pay, log in, and use, with zero-touch provisioning	
	Pricing Model	Hardware costs			Free	Device license fee	
	Cloud Access	√ (Free)			√ (Free)	√ (Device license fee)	
Hardware Design	Interface	2 × 10/100 Mbps Ethernet Ports; 1 × USB 2.0 Port; 1 × Micro USB Port	2 × Gigabit Ethernet Ports; 1 × USB 3.0 Port	2 × 10G SFP+ Ports; 4 × Gigabit Ethernet Ports; 2 × USB 3.0 Ports	-	-	
	Power Supply	802.3af/at PoE; Micro USB (DC 5 V / Minimum 1A)	100~240 VAC; 50/60 Hz	100~240 VAC; 50/60 Hz; Redundant Power Supply	-	-	
	Dimensions	3.9 × 3.9 × 1.0 in (100 × 98 × 25 mm)	11.6 × 7.1 × 1.7 in (294 × 180 × 44 mm)	17.3 × 7.1 × 1.7 in (440 × 180 × 44 mm)	-	-	
Device Management	Environment	Operating Temperature: 0~40 °C (32~104 °F); Storage Temperature: -40~70 °C (-40~158 °F); Operating Humidity: 10~90% RH non-condensing; Storage Humidity: 5~90% RH non-condensing				-	-
	Support Devices	Omada Access Points, L3/L2+ Managed, Smart, and Easy Managed Switches, and Routers					
	Management Scale	≤100 APs + 20 Switches + 10 Routers; ≤1,000 Clients	≤500 APs + 100 Switches + 100 Routers; ≤15,000 Clients	≤1000 APs + 200 Switches + 100 Routers; ≤30,000 Clients	Unlimited (Recommends 10,000)*	Unlimited**	
System Management	Network Type	Small/Medium networks			Medium/Large networks	Medium/Large multi-site networks	
	AP Automatic Discovery				√		
	AP Unified Configuration				√		
	VPN				√		
	Zero-Touch Provisioning	-	-	-	-	√	
Security	L3 Management				√		
	Multi-Site Management				√		
	Multi-User Privilege Assignment				√		
	Wi-Fi Heatmap Simulator				√		
	Network Summary Report				√		
	Abnormal Event Warnings and Notifications				√		
	Batch Configuration				√		
	Batch Firmware Upgrading				√		
	Online Firmware Upgrade				√		
	Reboot Schedule				√		
Wireless Function	Management VLAN				√		
	MAC Filter				√		
	Encryption	WPA-Personal/Enterprise, WPA2-Personal/Enterprise, WPA3-SAE/Enterprise					
	Access Control				√		
	SSID to VLAN Mapping				√		
Wireless Function	Automatic Channel Selection				√		
	Automatic Transmit Power Adjustment				√		
	Captive Portal	SMS, Voucher, Local User, Simple Password, External RADIUS Portal					
	Seamless Roaming / AI Roaming				√		
	Mesh				√		
	Band Steering				√		
	Load Balance				√		
	Beamforming				√		
Rate Limit	Based on SSID/Client						
Wireless Schedule				√			

\* Actual management scale of the Omada Software Controller depends on the PC/server's hardware specifications









\*\*The management scale of the Omada Cloud-Based Controller may depend on the quantity of purchased device licenses. Go to [www.tp-link.com/en/omada-cloud-based-controller/product-list/](http://www.tp-link.com/en/omada-cloud-based-controller/product-list/) to find all the models supported by Omada Cloud-Based Controller.

# Omada Wi-Fi 7 Access Points

		Ceiling Mount APs	
		Wi-Fi 7	
Product Picture			
Model		EAP783	EAP773
Product Description		BE22000 Ceiling Mount Wi-Fi 7 Access Point	BE11000 Ceiling Mount Wi-Fi 7 Access Point
Main Design	Wi-Fi Class	US: BE22000 EU: BE19000	US: BE11000 EU: BE9300
	Wi-Fi Speed (2.4 GHz)	1376 Mbps	574 Mbps
	Wi-Fi Speed (5 GHz)	8640 Mbps (US version) 5760 Mbps (EU version)	4320 Mbps (US version) 2880 Mbps (EU version)
	Wi-Fi Speed (6 GHz)	11520 Mbps	5760 Mbps
	Ethernet Ports	2x 10 G	1x 10 G
	EHT320		✓
	Bluetooth		✓
	Power Supply	802.3bt PoE or 12V DC	802.3at/bt PoE or 12V DC
	Mounting	Ceiling/ Wall mounting (Kits included)	
	Dimensions (WxDxH)	11.0x11.0x1.8 in (280x280x45 mm)	8.7x8.7x1.3 in (220x220x32.5 mm)
	Concurrent Clients	640	384
Management	Omada Software Controller		✓
	Omada Hardware Controller		✓
	Cloud Access		✓
	Omada App		✓
	Standalone Management		✓
Wireless Functions	4096-QAM		✓
	Multi-Link Operation (MLO)		✓
	Multi-RU		✓
	4x Longer OFDM Symbol		✓
	OFDMA		✓
	BSS Coloring		✓
	MU-MIMO		✓
	Mesh*		✓
	Seamless Roaming / AI Roaming*		✓
	Beamforming		✓
	Airtime Fairness		✓
	Automatic Channel Selection*		✓
	Transmit Power Control	Adjust Transmit Power on dBm	
	Multiple SSIDs	24 (8 on each radio)	
Others	Band Steering, Load Balancing, Rate Limit, Wireless / Reboot Schedule		
Security	Captive Portal*	SMS, Voucher, Local User, Simple Password, External RADIUS Portal	
	Access Control		✓
	Wireless MAC Address Filtering		✓
	SSID to VLAN Mapping		✓
	Rogue AP Detection		✓
	802.1X Support		✓
	WPA3		✓
Encryption	WPA-Personal/Enterprise, WPA2-Personal/Enterprise, WPA3-Personal/Enterprise		

\*These functions require the use of Omada SDN controllers.





# Omada Ceiling Mount Access Points

		Ceiling Mount APs							
		Wi-Fi 6							
Wi-Fi Class		AX6000		AX5400	AX3600	AX3000		AX1800	
Product Picture									
Model		EAP683 UR	EAP680	EAP673 / EAP670 (v2)	EAP660 HD (v2 and above)	EAP653 UR	EAP653 (1/5-pack) / EAP650	EAP620 HD	EAP613 (1/5-pack) / EAP610
Product Description		AX6000 Ceiling Mount Wi-Fi 6 Access Point		AX5400 Ceiling Mount Wi-Fi 6 Access Point	AX3600 Ceiling Mount Wi-Fi 6 Access Point	AX3000 Ceiling Mount Wi-Fi 6 Access Point		AX1800 Ceiling Mount Wi-Fi 6 Access Point	
Main Design	Wi-Fi Speed (2.4 GHz)	1148 Mbps	1148 Mbps	574 Mbps	1148 Mbps	574 Mbps	574 Mbps	574 Mbps	574 Mbps
	Wi-Fi Speed (5 GHz)	4804 Mbps	4804 Mbps	4804 Mbps	2402 Mbps	2402 Mbps	2402 Mbps	1201 Mbps	1201 Mbps
	Ethernet Ports	1× 2.5 G	1× 2.5 G	1× 2.5 G	1× 2.5 G	1× GE	1× GE	1× GE	1× GE
	Antennas	4× 4 dBi (2.4 GHz) 4× 5 dBi (5 GHz) 1 Bluetooth Internal Antenna	4× 4 dBi (2.4 GHz) 4× 5 dBi (5 GHz) 1 Bluetooth Internal Antenna	2× 5 dBi (2.4 GHz) 4× 5 dBi (5 GHz) 1 Bluetooth Internal Antenna	4 Antennas (2.4 GHz) 4 Antennas (5 GHz) 1 Bluetooth Internal Antenna	2 Antennas (2.4 GHz) 3 Antennas (5 GHz) 1 Bluetooth Internal Antenna	2× 4 dBi (2.4 GHz) 2× 5 dBi (5 GHz)	2× 4 dBi (2.4 GHz) 2× 5 dBi (5 GHz)	2× 4 dBi (2.4 GHz) 2× 5 dBi (5 GHz)
	HE160	✓	✓	✓	-	✓	✓	-	-
	Bluetooth	✓	✓	✓	✓	✓	-	-	-
	Power Supply	802.3at PoE or 12V/2A DC	802.3at PoE or 12V/2A DC (DC Adapter included)	802.3at PoE or 12V/2A DC (DC Adapter included in the box of EAP670)	802.3at PoE or 12V DC (DC Adapter included)	802.3at PoE or 48V Passive PoE	802.3at PoE or 48V Passive PoE or 12V/1.2A DC (DC Adapter included in the box of EAP650)	802.3at PoE or 48V Passive PoE or 12V/1.5A DC (DC Adapter included)	802.3at PoE or 48V Passive PoE or 12V/1A DC (DC Adapter included in the box of EAP610)
	Mounting	Ceiling/ Wall mounting (Kits included)							
	Dimensions (W×D×H)	8.7×8.7×1.3 in (220×220×32.5 mm)				6.3 × 6.3 × 1.3 in (160 × 160 × 33.6 mm)			
	Concurrent Clients	512	512	256	1024	256	256	1024	256
Environment	Operating Temperature: 0–40 °C (32–104 °F); Storage Temperature: -40–70 °C (-40–158 °F); Operating Humidity: 10–90% RH non-condensing; Storage Humidity: 5–90% RH non-condensing								
Management	Omada Software Controller					✓			
	Omada Hardware Controller					✓			
	Cloud Access					✓			
	Omada App					✓			
	Standalone Management					✓			
Wireless Functions	1024-QAM					✓			
	4× Longer OFDM Symbol					✓			
	OFDMA					✓			
	BSS Coloring					✓			
	MU-MIMO					✓			
	Mesh*					✓			
	Seamless Roaming / AI Roaming*					✓			
	Beamforming					✓			
	Airtime Fairness					✓			
	Automatic Channel Selection					✓			
	Transmit Power Control	Adjust Transmit Power on dBm							
	Multiple SSIDs	16 (8 on each radio)							
Others	Band Steering, Load Balancing, Rate Limit, Wireless / Reboot Schedule								
Security	Captive Portal*	SMS, Voucher, Local User, Simple Password, External RADIUS Portal							
	Access Control					✓			
	Wireless MAC Address Filtering					✓			
	SSID to VLAN Mapping					✓			
	Rogue AP Detection					✓			
	802.1X Support					✓			
	WPA3					✓			
Encryption	WPA-Personal/Enterprise, WPA2-Personal/Enterprise, WPA3-Personal/Enterprise								

\*Omada Mesh, Seamless Roaming, and Captive Portal require the use of Omada SDN controllers.









# Omada Ceiling Mount Access Points

		Ceiling Mount APs				
		Wi-Fi 5			Wi-Fi 4	
Wi-Fi Class		AC1750		AC1350	N300	
Product Picture						
Model		EAP265 HD	EAP245 (1/5-pack)	EAP225 / EAP223	EAP115	EAP110
Product Description		AC1750 Wireless MU-MIMO Gigabit Ceiling Mount Access Point		AC1350 Wireless MU-MIMO Gigabit Ceiling Mount Access Point	300Mbps Wireless N Ceiling Mount Access Point	
Main Design	Wi-Fi Speed (2.4 GHz)	450 Mbps	450 Mbps	450 Mbps	300 Mbps	300 Mbps
	Wi-Fi Speed (5 GHz)	1300 Mbps	1300 Mbps	867 Mbps	-	-
	Ethernet Ports	2× GE	2× GE	1× GE	1× 10/100 Mbps	1× 10/100 Mbps
	Antennas	3× 3.5 dBi (2.4 GHz) 3× 4 dBi (5 GHz)	3× 3.5 dBi (2.4 GHz) 3× 4 dBi (5 GHz)	3× 3.5 dBi (2.4 GHz) 2× 4 dBi (5 GHz)	2× 4 dBi (2.4 GHz)	2× 4 dBi (2.4 GHz)
	Power Supply	802.3af PoE or Passive PoE (PoE Adapter included)		802.3af PoE or Passive PoE (PoE Adapter included in the box of EAP225)	802.3af PoE or 9V/0.6A DC (Power Adapter included)	24V Passive PoE (Power Adapter included)
	Mounting	Ceiling/ Wall mounting (Kits included)				
	Dimensions (W×D×H)	8.1 × 7.1 × 1.5 in (205.5×181×37.1 mm)			7.5×6.8×1.2 in (189.4×172.3×29.5 mm)	
	Concurrent Clients	640	228	228	100	100
	Environment	Operating Temperature: 0–40 °C (32–104 °F); Storage Temperature: -40–70 °C (-40–158 °F); Operating Humidity: 10–90% RH non-condensing; Storage Humidity: 5–90% RH non-condensing				
Management	Omada Software Controller				✓	
	Omada Hardware Controller				✓	
	Cloud Access				✓	
	Omada App				✓	
	Standalone Management				✓	
Wireless Functions	MU-MIMO	✓		-		
	Mesh*	✓		-		
	Seamless Roaming / AI Roaming*	✓		-		
	Beamforming	✓		-		
	Airtime Fairness, Band Steering	✓		-		
	Automatic Channel Selection				✓	
	Transmit Power Control	Adjust Transmit Power on dBm				
	Multiple SSIDs	16 (8 on each radio)			8	
	Others	Load Balancing, Rate Limit, Wireless / Reboot Schedule				
Security	Captive Portal*	SMS, Voucher, Local User, Simple Password, External RADIUS Portal				
	Access Control				✓	
	Wireless MAC Address Filtering				✓	
	SSID to VLAN Mapping				✓	
	Rogue AP Detection				✓	
	802.1X Support				✓	
	WPA3				-	
	Encryption	WPA-Personal/Enterprise, WPA2-Personal/Enterprise				







\*Omada Mesh, Seamless Roaming, and Captive Portal require the use of Omada SDN controllers.

# Omada Wall Plate Access Points

		Wall Plate APs							
		Wi-Fi 6			Wi-Fi 5		Wi-Fi 4		
Wi-Fi Class		AX5400	AX3000		AX1800	AC1200		N300	
Product Picture									
Model		EAP673-Extender***	EAP655-Wall	EAP650-Wall	EAP615-Wall	EAP235-Wall	EAP230-Wall	EAP115-Wall	
Product Description		AX5400 Wall Plate Wi-Fi 6 Extender	AX3000 Wall Plate Wi-Fi 6 Access Point		AX1800 Wall Plate Wi-Fi 6 Access Point	AC1200 Wireless MU-MIMO Gigabit Wall Plate Access Point		300 Mbps Wireless N Wall Plate Access Point	
Main Design	Wi-Fi Speed (2.4 GHz)	574 Mbps	574 Mbps	574 Mbps	574 Mbps	300 Mbps	300 Mbps	300 Mbps	
	Wi-Fi Speed (5 GHz)	4804 Mbps	2402 Mbps	2402 Mbps	1201 Mbps	867 Mbps	867 Mbps	-	
	Ethernet Ports	1× GE	4× GE	2× GE	4× GE	4× GE	2× GE	2× 10/100 Mbps	
	Antennas	TBD	2× 3 dBi (2.4 GHz) 2× 5 dBi (5 GHz)	2× 3 dBi (2.4 GHz) 2× 5 dBi (5 GHz)	2× 4 dBi (2.4 GHz) 2× 4 dBi (5 GHz)	2× 4 dBi (2.4 GHz) 2× 4 dBi (5 GHz)	2× 4 dBi (2.4 GHz) 2× 3.6 dBi (5 GHz)	2× 1.8 dBi (2.4 GHz)	
	HE160	✓	✓	✓	-	-	-	-	
	Power Supply	100~240 VAC; 50/60 Hz (AC Plug)	802.3af/at PoE**	802.3af PoE	802.3af/at PoE**	802.3af/at PoE**	802.3af PoE	802.3af PoE	
	PoE Passthrough	-	✓	-	✓	✓	-	-	
	Mounting	Wall Plate Mounting (Kits Included)							
	Dimensions (W×D×H)	TBD	5.6×3.4×1.7 in (143×86×42.6 mm)	3.4×3.4×1.7 in (86.8×86.8×42.6 mm)	5.6×3.4×0.8 in (143×86×20 mm)	5.6×3.4×0.8 in (143×86×20 mm)	3.4×3.4×1.2 in (86.8×86.8×30.2 mm)	3.4×3.4×1.2 in (86.8×86.8×30.2 mm)	
	Concurrent Clients	256	128	128	128	200	200	100	
Environment	Operating Temperature: 0~40 °C (32~104 °F); Storage Temperature: -40~70 °C (-40~158 °F); Operating Humidity: 10~90% RH non-condensing; Storage Humidity: 5~90% RH non-condensing								
Management	Omada Software Controller				✓				
	Omada Hardware Controller				✓				
	Cloud Access				✓				
	Omada App				✓				
	Standalone Management				✓				
Wireless Functions	1024-QAM			✓			-		
	4× Longer OFDM Symbol			✓			-		
	OFDMA			✓			-		
	BSS Coloring			✓			-		
	MU-MIMO	✓	-	-	✓	✓	✓	-	
	Mesh*	✓	-	-	-	-	-	-	
	Seamless Roaming / AI Roaming*			✓			-		
	Beamforming			✓			✓	✓	-
	Band Steering			✓			✓	✓	-
	Automatic Channel Selection			✓			✓		
	Transmit Power Control	Adjust Transmit Power on dBm							
	Multiple SSIDs	16 (8 on each radio)			16 (8 on each radio)		8		
Others	Load Balancing, Rate Limit, Wireless / Reboot Schedule								
Security	Captive Portal*	SMS, Voucher, Local User, Simple Password, External RADIUS Portal							
	Access Control				✓				
	Wireless MAC Address Filtering				✓				
	SSID to VLAN Mapping				✓				
	Rogue AP Detection				✓				
	802.1X Support				✓				
	WPA3			✓			-		
Encryption	WPA-Personal/Enterprise, WPA2-Personal/Enterprise, WPA3-Personal/Enterprise				WPA-Personal/Enterprise, WPA2-Personal/Enterprise				



\*Omada Mesh, Seamless Roaming, and Captive Portal require the use of Omada SDN controllers.  
 \*\*802.3at PoE power supply is required when PoE passthrough of these wall plate access points is used.  
 \*\*\*These products are being developed, and the product images and specifications may vary then

# Omada Outdoor Access Points

		Outdoor APs						
		Wi-Fi 6				Wi-Fi 5	Wi-Fi 4	
Wi-Fi Class		AX3000	AX1800			AC1200	N300	
Product Picture								
Model		EAP650-Outdoor	EAP625-Outdoor HD	EAP623-Outdoor HD	EAP610-Outdoor	EAP225-Outdoor	EAP113-Outdoor	EAP110-Outdoor
Product Description		AX3000 Indoor/Outdoor Wi-Fi 6 Access Point	AX1800 Indoor/Outdoor Wi-Fi 6 Access Point			AC1200 Wireless MU-MIMO Gigabit Indoor/Outdoor Access Point	300Mbps Wireless N Outdoor Access Point	
Main Design	Wi-Fi Speed (2.4 GHz)	574 Mbps	574 Mbps	574 Mbps	574 Mbps	300 Mbps	300 Mbps	300 Mbps
	Wi-Fi Speed (5 GHz)	2402 Mbps	1201 Mbps	1201 Mbps	1201 Mbps	867 Mbps	-	-
	Ethernet Ports	1× GE	1× GE	1× GE	1× GE	1× GE	1× 10/100 Mbps	1× 10/100 Mbps
	Antennas	2×4 dBi (2.4 GHz) 2×5 dBi (5 GHz)	2×3 dBi (2.4 GHz) 2×5 dBi (5 GHz)	2×4 dBi (2.4 GHz) 2×5 dBi (5 GHz)	2×4 dBi (2.4 GHz) 2×5 dBi (5 GHz)	2×3 dBi (2.4 GHz) 2×4 dBi (5 GHz)	2× 3 dBi (2.4 GHz)	2× 3 dBi (2.4 GHz)
	HE160	√	-	-	-	-	-	-
	Power Supply	802.3at PoE or 48V Passive PoE (Adapter included)	802.3at PoE or 48V Passive PoE	802.3at PoE or 48V Passive PoE	802.3at PoE or 48V Passive PoE (Adapter included)	802.3af PoE or 24V Passive PoE (Adapter included)	802.3af PoE or 48V Passive PoE	24V Passive PoE (Adapter included)
	Weatherproof	IP67	IP67	IP67	IP67	IP65	IP65	IP65
	Mounting	Pole/Wall Mounting (Kits Included)						
	Dimensions (W×D×H, without antenna & mounting kit)	11.0×4.2×2.2 in (280.4×106.5×56.8 mm)	11.0×7.2×2.2 in (280.4×182.2×56.9 mm)	11.0×4.2×2.2 in (280.4×106.5×56.8 mm)			8.5×1.8×1.1 in (215×46×27 mm)	
	Concurrent Clients	256	1024	1024	256	228	100	100
	Environment	Operating Temperature: -30~70 °C (-22~158 °F); Storage Temperature: -40~70 °C (-40~158 °F); Operating Humidity: 10~90% RH non-condensing; Storage Humidity: 5~90% RH non-condensing						
Management	Omada Software Controller						√	
	Omada Hardware Controller						√	
	Cloud Access						√	
	Omada App						√	
	Standalone Management						√	
Wireless Functions	1024-QAM	√					-	
	4× Longer OFDM Symbol	√					-	
	OFDMA	√					-	
	BSS Coloring	√					-	
	MU-MIMO	√			√		-	
	Repeater Mode	√					√	
	Mesh*	√			√		-	
	Seamless Roaming / AI Roaming*	√			√		-	
	Beamforming	√			√		-	
	Airtime Fairness, Band Steering	√			√		-	
	Automatic Channel Selection	√					√	
	Transmit Power Control	Adjust Transmit Power on dBm						
	Multiple SSIDs	16 (8 on each radio)				16 (8 on each radio)		8
Others	Load Balancing, Rate Limit, Wireless / Reboot Schedule							
Security	Captive Portal*	SMS, Voucher, Local User, Simple Password, External RADIUS Portal						
	Access Control						√	
	Wireless MAC Address Filtering						√	
	SSID to VLAN Mapping						√	
	Rogue AP Detection						√	
	802.1X Support						√	
	WPA3	√					-	
Encryption	WPA-Personal/Enterprise, WPA2-Personal/Enterprise, WPA3-Personal/Enterprise				WPA-Personal/Enterprise, WPA2-Personal/Enterprise			



\*Omada Mesh, Seamless Roaming, and Captive Portal require the use of Omada SDN controllers.

# Omada Outdoor Bridge

		Outdoor Bridge		
		Wi-Fi 5		Wi-Fi 4
Wi-Fi Class		AC867		N300
Product Picture				
Model		EAP215-Bridge KIT	EAP211-Bridge KIT	EAP115-Bridge KIT
Product Description		5GHz 867Mbps Long-range Indoor/Outdoor Access Point		5GHz 300Mbps Long-range Indoor/Outdoor Access Point
Main Design	Wi-Fi Speed (2.4 GHz)	-	-	-
	Wi-Fi Speed (5 GHz)	867 Mbps	867 Mbps	300 Mbps
	Ethernet Ports	3× GE	3× GE	3× 10/100 Mbps
	Antennas	2× 11 dBi (5 GHz)	2× 7 dBi (5 GHz)	2× 11 dBi (5 GHz)
	Power Supply	Passive PoE and 12V DC (Adapter included)		
	Weatherproof	IP65	IP65	IP65
	Mounting	Pole/Wall Mounting (Kits Included)		
	Dimensions (W×D×H, without mounting kit)	8.8×3.1×2.4 in (224×79×60 mm)		
	Environment	Operating Temperature: -40–70 °C (-40–158 °F); Storage Temperature: -40–70 °C (-40–158 °F); Operating Humidity: 10–90% RH non-condensing; Storage Humidity: 5–90% RH non-condensing		
Management	Omada Software Controller	✓		
	Omada Hardware Controller	✓		
	Cloud Access	✓		
	Omada App	✓		
	Standalone Management	✓		
Wireless Functions	Mesh*	✓		
	Seamless Roaming / AI Roaming*	-		
	Beamforming	✓		
	Airtime Fairness	✓		

\*Omada Mesh, Seamless Roaming, and Captive Portal require the use of Omada SDN controllers.





# Omada Desktop Access Points and GPON Access Points

		Desktop APs	GPON Desktop APs	GPON Wall Plate APs
		Wi-Fi 6	Wi-Fi 6	Wi-Fi 6
Wi-Fi Class		AX3000	AX1800	AX1800
Product Picture				
Model		EAP650-Desktop***	EAP610GP-Desktop***	EAP615GP-Wall***
Product Description		AX3000 Desktop Wi-Fi 6 Access Point	AX1800 Desktop Wi-Fi 6 GPON Access Point	AX1800 Wall Plate Wi-Fi 6 GPON Access Point
Main Design	Wi-Fi Speed (2.4 GHz)	574 Mbps	574 Mbps	574 Mbps
	Wi-Fi Speed (5 GHz)	2402 Mbps	1201 Mbps	1201 Mbps
	Ports	4× GE RJ45, 1× RJ11	4× GE RJ45, 1× RJ11, 1× PON	2× GE RJ45, 1× RJ11, 1× PON
	HE160	✓	-	-
	Power Supply	802.3af/at PoE** and DC (Adapter included)	DC (Adapter included)	100~240 VAC; 50/60 Hz (AC Plug)
	PoE Passthrough	✓	802.3af PoE Out	-
	Mounting	Desktop/Wall-Mounting (Kits Included)	Desktop/Wall-Mounting (Kits Included)	Wall Plate Mounting (Kits Included)
	Dimensions (W×D×H)	175×140×33 mm (TBD)	175×140×33 mm (TBD)	143×86×38 mm (TBD)
	Environment	Operating Temperature: 0~40 °C (32~104 °F); Storage Temperature: -40~70 °C (-40~158 °F); Operating Humidity: 10~90% RH non-condensing; Storage Humidity: 5~90% RH non-condensing		
Management	Omada Software Controller		✓	
	Omada Hardware Controller		✓	
	Cloud Access		✓	
	Omada App		✓	
	Standalone Management		✓	
Wireless Functions	1024-QAM		✓	
	4× Longer OFDM Symbol		✓	
	OFDMA		✓	
	BSS Coloring		✓	
	MU-MIMO		✓	
	Mesh*		✓	
	Seamless Roaming / AI Roaming*		✓	
	Beamforming		✓	
	Airtime Fairness		✓	
	Automatic Channel Selection		✓	
	Transmit Power Control	Adjust Transmit Power on dBm		
	Multiple SSIDs	16 (8 on each radio)		
	Others	Band Steering, Load Balancing, Rate Limit, Wireless / Reboot Schedule		
Security	Captive Portal*	SMS, Voucher, Local User, Simple Password, External RADIUS Portal		
	Access Control		✓	
	Wireless MAC Address Filtering		✓	
	SSID to VLAN Mapping		✓	
	Rogue AP Detection		✓	
	802.1X Support		✓	
	WPA3		✓	
	Encryption	WPA-Personal/Enterprise, WPA2-Personal/Enterprise, WPA3-Personal/Enterprise		

\*Omada Mesh, Seamless Roaming, and Captive Portal require the use of Omada SDN controllers.  
 \*\*802.3at PoE power supply is required when PoE passthrough of these access points is used.  
 \*\*\*These products are being developed, and the product images and specifications may vary then













# Omada L3 Managed Switches

		10 Gbps with 25G Uplink	1 Gbps with 10G Uplink			
Product Picture						
Model		SX6632YF	SG6654XHP	SG6654X	SG6428XHP	SG6428X
Layer		L3 Managed				
Hardware	Gigabit RJ45 Ports	-	48, all support PoE	48	24, all support PoE	24
	10G SFP+ Slots	26	6	6	4	4
	25G SFP28 Slots	6	-	-	-	-
	USB Ports	2× USB 3.0	2× USB 2.0	2× USB 2.0	2× USB 2.0	2× USB 2.0
	Other Ports	1× RJ45/USB Type C Console Combo Port, 1× RJ45 Management Port				
	Power Supply	100-240 VAC, 50/60 Hz				
	RPS (Redundant Power Supply)	√ (field-replaceable and hot-swappable)**	√ (field-replaceable and hot-swappable)**	√ (fixed)	√ (field-replaceable and hot-swappable)**	√ (fixed)
	Physical Stacking Number	4				
	Fans	4× Fans (field-replaceable and hot-swappable)	4× Fans (field-replaceable and hot-swappable)	4× Fans (fixed)	4× Fans (field-replaceable and hot-swappable)	4× Fans (fixed)
	Dimensions (W×D×H)	17.3×15.0×1.7 in (440×380×44 mm)	17.3×16.5×1.7 in (440×420×44 mm)	17.3×15.0×1.7 in (440×380×44 mm)	17.3×16.5×1.7 in (440×420×44 mm)	17.3×15.0×1.7 in (440×380×44 mm)
	Installation (Kits Included)	Rackmount				
	Operating Temperature	0-45 °C				
PoE	PoE Standard	-	802.3af/at	-	802.3af/at	-
	PoE Port	-	48	-	24	-
	PoE Power Budget	-	Up to 1440W*	-	Up to 720W*	-
	PoE Auto Recovery	-	√	-	√	-
Performance	Switching Capacity (Gbps)	820	216	216	128	128
	Forwarding Rate (Mpps)	610.1	160.7	160.7	95.2	95.2
	MAC Address Table	128K	32K			
	Packet Buffer	8 MB	3 MB			
L3 Features	Static Routing	√				
	PIM-DM	√				
	RIP	√				
	OSPF	√				
	Others	ECMP, Multicast Routing, VRRP, DHCP Server/Relay, ARP Proxy				
L2 Features	VLAN	802.1Q/MAC/Protocol/Private/Voice/Multicast/Management VLAN				
	QoS	√				
	Others	V1/V2/V3 IGMP Snooping, Multicast, STP/RSTP/MSTP, ERPS, Loopback Detection, IPv6, QinQ, MAC Flapping, Rate Limit, Port Isolation, Port Mirroring, Static LAG / LACP, DHCP Snooping				
Security	Security Functions	DoS Defend, Access Control List, IP + MAC + PORT + VID Binding, Storm Control, Port Security, SSH & SSL, IP Source Guard, Dynamic ARP Inspection, IEEE 802.1X Authentication				
System Management	Controller Mode	Omada Software/Hardware Controller; Omada App; Automatic Device Discovery; Batch Configuration; Batch Firmware Upgrading; Intelligent Network Monitoring; Abnormal Event Warnings; Unified Configuration; Reboot Schedule				
	Standalone Mode	CLI, SPAN/ RSPAN, sFlow, Cable Diagnostics, SNMP				

\*The PoE budgets of SG6428XHP and SG6654XHP vary with the power supply modules.

\*\*The field-replaceable redundant power supply requires purchasing separately.

# Omada L2+ Managed Switches

		Full 10G				2.5GE + 10G Uplink					
Product Picture											
Model		SX3206HPP	SX3032F*	SX3016F	SX3008F	SG3428XPP-M2	SG3218XP-M2	SG3210XHP-M2	SG3428X-M2	SG3210X-M2	SG2210XMP-M2
Layer		L2+ Managed									Smart
Hardware	2.5G RJ45 Ports	-	-	-	-	24, all support PoE	16 (ports 1-8 support PoE)	8, all support PoE	24	8	8, all support PoE
	10G RJ45 Ports	4, all support PoE	-	-	-	-	-	-	-	-	-
	10G SFP+ Slots	2	32	16	8	4	2	2	4	2	2
	Console Ports	1 (RJ45) + 1 (Micro-USB)									-
	Power Supply	100-240 VAC, 50/60 Hz									53.5VDC/3.37A Power Adapter
	RPS (Redundant Power Supply)	-	√ (fixed)	√ (fixed)	-	-	-	-	-	-	-
	Fanless	2 Fans	2 Fans	1 Fan	√	3 Fans	2 Fans	2 Fans	1 Fan	√	√
	Dimensions (WxDxH)	294x180x44 mm	440x330x44 mm	440x220x44 mm	440x180x44 mm	440x330x44 mm	440x220x44 mm	440x180x44 mm	440x180x44 mm	294x180x44 mm	226x131.2x35 mm
	Installation (Kits Included)	Rackmount / Desktop	Rackmount	Rackmount	Rackmount	Rackmount	Rackmount	Rackmount	Rackmount	Rackmount / Desktop	Desktop/Wall-Mounting
	Operating Temperature	0-50 °C	0-45 °C	0-45 °C	0-50 °C	0-40 °C	0-40 °C	0-50 °C	0-40 °C	0-50 °C	0-40 °C
PoE	PoE Standard	802.3af/at/bt (Type 3)	-	-	-	802.3af/at/bt (Type 3)	802.3af/at	802.3af/at	-	-	802.3af/at
	PoE Port	4x PoE++ (up to 60W per port)	-	-	-	8x PoE++ (up to 60W per port) 16x PoE+	8x PoE+	8x PoE+	-	-	8x PoE+
	PoE Power Budget	200 W	-	-	-	500 W	240 W	240 W	-	-	160 W
	PoE Auto Recovery	√	-	-	-	√	√	√	-	-	√
Performance	Switching Capacity (Gbps)	120	640	320	160	200	120	80	200	80	80
	Forwarding Rate (Mpps)	89.3	476.2	238.1	119.0	148.8	89.3	59.5	148.8	59.5	59.5
	MAC Address Table	32 K				32 K	16 K	16 K	32 K	16 K	16 K
	Jumbo Frame	9 KB									
L2+ Features	Static Routing	√									
	DHCP Server/Relay	√									
	ARP Proxy	√									
L2 Features	IGMP Snooping	V1/V2/V3									
	STP/RSTP/MSTP	√									
	Loopback Detection	√									
	QinQ	√									
	VLAN	802.1Q/MAC/Protocol/Private/Voice VLAN									
	QoS	8 Queues, Port/802.1p/DSCP QoS									
	Rate Limit	√									
	Port Isolation	√									
	Port Mirroring	√									
	Link Aggregation	Static LAG / LACP									
Security	Security Functions	DoS Defend, Access Control List, IP + MAC + PORT + VID Binding, Storm Control, Port Security, SSH & SSL, IP Source Guard, Dynamic ARP Inspection, IEEE 802.1X Authentication									
	System Management	Controller Mode: Omada Software/Hardware Controller; Omada App; Automatic Device Discovery; Batch Configuration; Batch Firmware Upgrading; Intelligent Network Monitoring; Abnormal Event Warnings; Unified Configuration; Reboot Schedule									
	Standalone Mode	Web, CLI, SNMP, and RMON									













\*These products are being developed, and the product images and specifications may vary then.

# Omada L2+ Managed Switches

		1GE + 10G Uplink						1GE						
Product Picture														
Model		SG3452XMPP*	SG3452XP	SG3428XMPP	SG3428XMP	SG3452X	SG3428X	SG3428XF	SG3452P	SG3452	SG3428MP	SG3428	SG3210	
Layer		L2+ Managed												
Hardware	Gigabit RJ45 Ports	48, all support PoE	48, all support PoE	24, all support PoE	24, all support PoE	48	24	-	48, all support PoE	48	24, all support PoE	24	8	
	Gigabit SFP Slots	-	-	-	-	-	-	20	4	4	4	4	2	
	Gigabit RJ45/SFP Combo Ports	-	-	-	-	-	-	4	-	-	-	-	-	
	10G SFP+ Slots	4	4	4	4	4	4	4	-	-	-	-	-	
	Console Ports	1 (RJ45) + 1 (Micro-USB)												
	Power Supply	100-240 VAC, 50/60 Hz												
	RPS (Redundant Power Supply)	-	-	-	-	-	-	-	√ (fixed)	-	-	-	-	-
	Fanless	3 Fans	3 Fans	3 Fans	2 Fans	√	√	1 Fan	3 Fans	√	2 Fans	√	√	
	Dimensions (WxDxH)	440×330×44 mm	440×330×44 mm	440×330×44 mm	440×330×44 mm	440×220×44 mm	440×180×44 mm	440×220×44 mm	440×330×44 mm	440×220×44 mm	440×330×44 mm	440×180×44 mm	294×180×44 mm	
	Installation	Rackmount	Rackmount	Rackmount	Rackmount	Rackmount	Rackmount	Rackmount	Rackmount	Rackmount	Rackmount	Rackmount	Rackmount / Desktop	
Operating Temperature	0-40°C	0-40°C	0-40°C	0-45°C	0-45°C	0-45°C	0-45°C	0-45°C	0-40°C	0-40°C	0-45°C	0-45°C	0-45°C	
PoE	PoE Standard	802.3af/at/bt (Type 4)	802.3af/at	802.3af/at/bt (Type 4)	802.3af/at	-	-	-	802.3af/at	-	802.3af/at	-	-	
	PoE Port	8× PoE++ (up to 90W per port) 40× PoE+	48× PoE+	8× PoE++ (up to 90W per port) 16× PoE+	24× PoE+	-	-	-	48× PoE+	-	24× PoE+	-	-	
	PoE Power Budget	800 W(TBD)	500 W	500 W	384 W	-	-	-	384 W	-	384 W	-	-	
	PoE Auto Recovery	√	√	√	√	-	-	-	√	-	√	-	-	
Performance	Switching Capacity (Gbps)	176	176	128	128	176	128	128	104	104	56	56	20	
	Forwarding Rate (Mpps)	131.0	131.0	95.2	95.2	131.0	95.2	95.2	77.4	77.4	41.7	41.7	14.9	
	MAC Address Table	16 K							16 K	16 K	16 K	16 K	8 K	
	Jumbo Frame	9 KB												
L2+ Features	Static Routing	√												
	DHCP Server/Relay	√												
	ARP Proxy	√												
L2 Features	IGMP Snooping	V1/V2/V3												
	STP/RSTP/MSTP	√												
	Loopback Detection	√												
	QinQ	√												
	VLAN	802.1Q/MAC/Protocol/Private/Voice VLAN												
	QoS	8 Queues, Port/802.1p/DSCP QoS												
	Rate Limit	√												
	Port Isolation	√												
	Port Mirroring	√												
	Link Aggregation	Static LAG / LACP												
DHCP Snooping	√													
Security	Security Functions	DoS Defend, Access Control List, IP + MAC + PORT + VID Binding, Storm Control, Port Security, SSH & SSL, IP Source Guard, Dynamic ARP Inspection, IEEE 802.1X Authentication												
System Management	Controller Mode	Omada Software/Hardware Controller; Omada App; Automatic Device Discovery; Batch Configuration; Batch Firmware Upgrading; Intelligent Network Monitoring; Abnormal Event Warnings; Unified Configuration; Reboot Schedule												
	Standalone Mode	Web, CLI, SNMP, and RMON												

\*These products are being developed, and the product images and specifications may vary then.



# Omada Smart Switches

	GE											FE + GE		
Product Picture														
Model	SG2452LP**	SG2428P	SG2428LP	SG2218P	SG2218	SG2016P	SG2210MP	SG2210P	SG2008P	SG2005P-PD	SG2008	SL2428P		
Layer	Smart													
Hardware	10/100 Mbps RJ45 Ports	-	-	-	-	-	-	-	-	-	-	-	24, all support PoE	
	Gigabit RJ45 Ports	48 (ports 1-32 support PoE)	24, all support PoE	24 (ports 1-16 support PoE)	16, all support PoE	16	16 (ports 1-8 support PoE)	8, all support PoE	8, all support PoE	8 (ports 1-4 support PoE)	5 (ports 1-4 support PoE out)	8 (including 1 PD Port)	-	
	Gigabit SFP Slots	4	4	4	2	2	-	2	2	-	-	-	-	
	Gigabit RJ45/SFP Combo Ports	-	-	-	-	-	-	-	-	-	-	-	2	
	Power Supply	100-240 VAC, 50/60 Hz					53.5VDC/2.43A	100-240 VAC, 50/60 Hz	53.5 VDC / 1.31A			Obtain Power from 802.3af/at/bt PoE Source	12 VDC/1 A External Adapter or Obtain Power from PoE Source	100-240 VAC, 50/60 Hz
	Fanless	√	2 Fans	√	1 Fan	√	√	1 Fan	√	√	√	√	2 Fans	
	Dimensions (WxDxH)	440x330x44 mm	440x220x44 mm	440x220x44 mm	440x180x44 mm	440x180x44 mm	286x111.7x25.4 mm	294x180x44 mm	209x126x26 mm	209x126x26 mm	170x100x38.5 mm	209x126x26 mm	440x180x44 mm	
	Installation	Rackmount	Rackmount	Rackmount	Rackmount	Rackmount	Desktop/Wall-Mounting	Rackmount / Desktop	Desktop/Wall-Mounting	Desktop/Wall-Mounting	Pole/Wall-Mounting (Kits Included)	Desktop/Wall-Mounting	Rackmount	
	Weatherproof	-	-	-	-	-	-	-	-	-	IP55	-	-	
Operating Temperature	0-40°C	0-50°C	0-40°C	0-50°C	0-40°C	0-40°C	0-50°C	0-40°C	0-40°C	-40-60°C	0-40°C	0-50 °C		
PoE	PoE Standard	802.3af/at	802.3af/at	802.3af/at	802.3af/at	-	802.3af/at	802.3af/at	802.3af/at	802.3af/at	802.3af/at	PoE in: 802.3af/at/bt PoE out: 802.3af/at	-	802.3af/at
	PoE Port	32x PoE+	24x PoE+	16x PoE+	16x PoE+	-	8x PoE+	8x PoE+	8x PoE+	4x PoE+	4x PoE+ out 1x PoE++ in	-	24x PoE+	
	PoE Power Budget	230 W (TBD)	250 W	150 W	150 W	-	120 W	150 W	61 W	62 W	Up to 64 W*	-	250 W	
	PoE Auto Recovery	√	√	√	√	-	√	√	√	√	√	-	√	
Performance	Switching Capacity (Gbps)	104	56	56	36	36	32	20	20	16	10	16	12.8	
	Forwarding Rate (Mpps)	77.4	41.7	41.7	26.8	26.8	23.8	14.9	14.9	11.9	7.4	11.9	9.5	
	MAC Address Table	16 K	8 K											
	Jumbo Frame	9 KB												
L2+ Features	Static Routing	√												
	DHCP Server/Relay	√												
	ARP Proxy	√												
L2 Features	IGMP Snooping	V1/V2/V3												
	STP/RSTP/MSTP	√												
	Loopback Detection	√												
	QinQ	√												
	VLAN	802.1Q/MAC/Protocol/Voice VLAN												
	QoS	8 Queues, Port/802.1p/DSCP QoS												
	Rate Limit	√												
	Port Isolation	√												
	Port Mirroring	√												
	Link Aggregation	Static LAG / LACP												
Security	Security Functions	DoS Defend, Access Control List, IP + MAC + PORT + VID Binding, Storm Control, Port Security, SSH & SSL, IP Source Guard, Dynamic ARP Inspection, IEEE 802.1X Authentication												
System Management	Controller Mode	Omada Software/Hardware Controller; Omada App; Automatic Device Discovery; Batch Configuration; Batch Firmware Upgrading; Intelligent Network Monitoring; Abnormal Event Warnings; Unified Configuration; Reboot Schedule												
	Standalone Mode	Web, CLI, SNMP, and RMON												

\*PoE Power Budget of SG2005P-PD: 64 W when powered by 802.3bt Type 4 (90 W), 44 W when powered by 802.3bt Type 3 (60 W), 19 W when powered by 802.3at, 6 W when powered by 802.3af





\*\*These products are being developed, and the product images and specifications may vary then.

# Omada Easy Managed Switches

		GE		
Product Picture				
Model		ES210GP*	ES205GP*	ES205G
Layer		Easy Managed		
Hardware	Gigabit RJ45 Ports	9 (ports 1–8 support PoE)	5 (ports 1–4 support PoE)	5
	Gigabit RJ45/SFP Combo Ports	1	-	-
	Power Supply	53.5 VDC/2.43 A	53.5 VDC/1.31 A	5 VDC/ 0.6 A
	Fanless	√	√	√
	Dimensions (W×D×H)	209×126×26 mm	99.8×98×25 mm	100×98×25 mm
	Installation (Kits Included)	Desktop/Wall-Mounting	Desktop/Wall-Mounting	Desktop/Wall-Mounting
PoE	PoE Standard	802.3af/at	802.3af/at	-
	PoE Port	8	4	-
	PoE Power Budget	120W (TBD)	63W (TBD)	-
	PoE Auto Recovery	√	√	-
Performance	Switching Capacity (Gbps)	20	10	10
	Forwarding Rate (Mpps)	14.9	7.4	7.4
	MAC Address Table	8K	8K	8K
	Jumbo Frame	15K	15K	15K
Software Features	IGMP Snooping	V1/V2/V3		
	Loopback Detection	√		
	802.1Q VLAN	√		
	QoS	8 Queues, Port/802.1p/DSCP QoS		
	Rate Limit	√		
	Port Isolation	√		
	Port Mirroring	√		
	Static LAG Link Aggregation	√		
System Management	Controller Mode	Omada Software/Hardware Controller; Omada App; Automatic Device Discovery; Batch Configuration; Batch Firmware Upgrading; Intelligent Network Monitoring; Abnormal Event Warnings; Unified Configuration; Reboot Schedule		
	Standalone Mode	√		









\*These products are being developed, and the product images and specifications may vary then.

# Omada Easy Smart and Unmanaged Switches





		Multi-Gigabit Unmanaged Switches			
		10GE		2.5GE	
Product Picture					
Model		DS1008X	DS105X	DS108G-M2	DS105G-M2
Hardware	RJ45 Ports	8× 10GE	5× 10GE	8× 2.5GE	5× 2.5GE
	Casing	Metal			
	Fanless	1 Fan (Intelligent fan speed adjustment)	√	√	√
	Auto-Negotiation	100Mbps/1Gbps/2.5Gbps/5Gbps/10Gbps		100Mbps/1Gbps/2.5Gbps	
	Dimensions (W×D×H)	294×180×44 mm	226×131×35 mm	158×101×25 mm	100×98×25 mm
	Installation (Kits Included)	Rackmount/Desktop	Desktop/Wall-mounting	Desktop/Wall-mounting	Desktop/Wall-mounting
	Cable Requirements	Cat 5e: Max 5 Gbps (100 m) Cat 6: Max 10 Gbps (55 m), 5 Gbps (100 m) Cat 6a: Max 10 Gbps (100 m)		Cat 5e / Cate 6 / Cat 6a: Max 2.5 Gbps (100 m)	
	Operating Temperature	0–50 °C	0–40 °C	0–40 °C	0–40 °C
Performance	Switch Capacity (Gbps)	160	100	40	25
	Forwarding Rate (Mpps)	119.0	74.4	29.8	18.6
	MAC Address Table	16 K	16 K	4 K	4 K
	Jumbo Frame	12 KB	12 KB	12 KB	12 KB
Features	Plug and Play	√	√	√	√
	802.3X Flow Control	√	√	√	√
	802.1P/DSCP QoS	√	√	√	√
	Others	Green Technology, Flow Control, Rate Limit, IGMP Snooping			













# Omada Easy Smart and Unmanaged Switches

		Gigabit Easy Smart and Unmanaged Switches (Non-PoE)								
		Easy Smart					Unmanaged			
Product Picture										
Model		DS1024GE	DS1016GE	DS116GE	DS108GE	DS105GE	DS1024G	DS1016G	DS108G	DS105G
Hardware	Gigabit RJ45 Ports	24	16	16	8	5	24	16	8	5
	Casing	Metal								
	Fanless	✓	✓	✓	✓	✓	✓	✓	✓	✓
	Dimensions	440×140×44 mm	440×140×44 mm	286×111.7×25.4 mm	158×101×25 mm	100×98×25 mm	440×140×44 mm	440×140×44 mm	158×101×25 mm	100×98×25 mm
	Installation	Rackmount			Desktop / Wall Mounting		Rackmount		Desktop / Wall Mounting	
PoE	-	-	-	-	-	-	-	-	-	
Performance	Switching Capacity (Gbps)	48	32	32	16	10	48	32	16	10
	Forwarding Rate (Mpps)	35.7	23.8	23.8	11.9	7.4	35.7	23.8	11.9	7.4
	MAC Address	8K	8K	8K	4K	2K	8K	8K	4K	2K
	Jumbo Frame	10 KB	10 KB	10 KB	16 KB	16 KB	10 KB	10 KB	16 KB	16 KB
	Green Tech	✓	✓	✓	✓	✓	✓	✓	✓	✓
Features	Management	Web-based user interface and management utility*					-	-	-	-
	802.1p/DSCP QoS	✓	✓	✓	✓	✓	✓	✓	✓	✓
	IGMP Snooping	✓	✓	✓	✓	✓	-	-	✓	✓
	MTU/Port/Tag VLAN	✓	✓	✓	✓	✓	MTU VLAN (Isolation Mode)		-	-
	Loop Prevention	✓	✓	✓	✓	✓	✓	✓	✓	✓
	Link Aggregation	✓	✓	✓	✓	✓	-	-	-	-
	Network Monitoring	Port Mirroring, Loop Prevention, and Cable Diagnostics					-	-	-	-
	Rate Limit	✓	✓	✓	✓	✓	-	-	-	-
	Storm Control	✓	✓	✓	✓	✓	-	-	-	-

\*Omada Easy Smart switches are Plug and Play compatible and can be easily managed via web-based user interface and management utility. However, they do not support Omada SDN central management.

		Unmanaged PoE Switches						
		GE			FE			
Product Picture								
Model		DS1018GMP	DS110GMP	DS108GP	DS106GPP	DS105GP	DS111P	DS106P
Hardware	10/100 Mbps RJ45 Ports	-	-	-	-	-	8	6
	Gigabit RJ45 Ports	16	9	8	6	5	2	-
	Gigabit Fiber Ports	-	-	-	-	-	1× SFP	-
	Gigabit RJ45/SFP Combo Ports	2	1	-	-	-	-	-
	Casing	Metal						
	Fanless	-	✓	✓	✓	✓	✓	✓
	Dimensions	440×180×44 mm	209×126×26 mm	158×101×25 mm	158×101×25 mm	100×98×25 mm	209×126×26 mm	158×101×25 mm
Installation	Rackmount		Desktop / Wall Mounting					
PoE	16 ports, 802.3af/at, 250 W PoE Budget	8 ports, 802.3af/at, 123 W PoE Budget	8 ports, 802.3af/at, 65 W PoE Budget	4 ports, 802.3af/at/bt type 3 (Port 1), 802.3af/at (Ports 2-4), 64 W PoE Budget	4 ports, 802.3af/at, 65 W PoE Budget	8 ports, 802.3af/at, 65 W PoE Budget	4 ports, 802.3af/at, 67 W PoE Budget	
Performance	Switching Capacity (Gbps)	36	20	16	12	10	7.6	1.2
	Forwarding Rate (Mpps)	26.8	14.9	11.9	8.9	7.4	5.7	0.9
	MAC Address	8K	4K	4K	2K	2K	2K	2K
	Jumbo Frame	10 KB	16 KB	16 KB	16 KB	16 KB	16 KB	2 KB
Features	Priority Mode	Ports 1-4	Ports 1-2	-	-	-	-	Ports 1-2
	Extend Mode	Ports 1-4	Ports 1-4	Ports 1-2	Ports 1-2	Ports 1-2	Ports 1-4/1-8	Ports 1-4
	Isolation Mode	Ports 1-8/9-16	Ports 1-4/5-8	-	-	-	Ports 1-8	-
	PoE Auto Recovery	Ports 1-16	Ports 1-8	Ports 1-8	Ports 1-4	Ports 1-4	Ports 1-8	Ports 1-4
	Green Tech	✓	✓	✓	✓	✓	✓	✓
	802.1p/DSCP QoS	✓	✓	✓	✓	✓	-	-
IGMP Snooping	-	✓	✓	✓	✓	✓	-	

# Omada Routers

	Wired Routers					Integrated Routers		Wi-Fi Routers		4G Wi-Fi Routers	
	10GE	2.5GE		GE		10GE	GE	GE		GE	
Product Picture											
Model	ER8411	ER7412-M2*	ER707-M2	ER7206 (v2)	ER605 (v2)	ER8411C-M2*	ER7212PC	ER706W	ER605W*	ER706W-4G	
Main Design	Ports	• 2× 10G SFP+ (1 WAN, 1 WAN/LAN) • 1× GE SFP WAN/LAN • 8× GE RJ45 WAN/LAN	• 2× 2.5G RJ45 WAN/LAN • 2× GE SFP WAN/LAN • 8× GE RJ45 WAN/LAN	• 2× 2.5G RJ45 (1 WAN, 1 WAN/LAN) • 1× GE SFP WAN/LAN • 4× GE RJ45 WAN/LAN	• 5× GE RJ45 (1 WAN, 4 WAN/LAN) • 1× GE SFP WAN/LAN	• 5× GE RJ45 (1 WAN, 2 WAN/LAN, 2 LAN)	• 2× 10G SFP+ (1 WAN, 1 WAN/LAN) • 1× 2.5G RJ45 WAN/LAN • 8× GE RJ45 WAN/LAN	• 10× GE RJ45 (1 WAN, 1 WAN/LAN, 8 PoE+ LAN) • 2× GE SFP WAN/LAN	• 5× GE RJ45 (1 WAN, 4 WAN/LAN) • 1× GE SFP WAN/LAN	• 5× GE RJ45 (1 WAN, 2 WAN/LAN, 2 LAN)	• 5× GE RJ45 (1 WAN, 4 WAN/LAN) • 1× GE SFP WAN/LAN • 1× Nano SIM Card Slot
	Number of WAN Ports	Up to 10 WAN	Up to 11 WAN	Up to 6 WAN	Up to 5 WAN	Up to 3 WAN	Up to 10 WAN	Up to 4 WAN	Up to 5 WAN	Up to 3 WAN	Up to 5 WAN
	Console Ports	1× RJ45	1× RJ45	-	-	-	-	-	-	-	-
	USB Ports†	2× USB 3.0 (One Supports LTE backup)	1× USB 3.0 (Supports LTE backup)	1× USB 2.0 (Supports LTE backup)	1× USB 3.0 (Supports LTE backup)	1× USB 2.0 (Supports LTE backup)	1× USB 3.0 (Supports LTE backup)	-	1× USB 3.0 (Supports LTE backup)	-	-
	PoE	-	-	-	-	-	-	8× GE RJ45 LAN PoE+ Ports, 110W PoE Budget	-	-	-
	Embedded Controller	-	-	-	-	-	√	√	-	-	-
	Wi-Fi	-	-	-	-	-	-	-	AX3000 Wi-Fi 6 (574+2402)	AC1350 Wi-Fi 5 (450+867)	AX3000 Wi-Fi 6 (574+2402)
	4G LTE	-	-	-	-	-	-	-	-	-	4G+ Cat6 300 Mbps
	RPS (Redundant Power Supply)	√ (fixed)	-	-	-	-	-	-	-	-	-
	Processor	Quad-Core, 2.2 GHz	Quad-Core	Dual-Core	Dual-Core	Dual-Core	Quad-Core	Dual-Core	Dual-Core	Single-Core	Dual Core
Dimensions (W×D×H)	440×220×44 mm	294×180×44 mm	226×131×35 mm	226×131×35 mm	158×101×25 mm	440×220×44 mm	226×131×35 mm	226×131×35 mm	215×117×32 mm	226×131.2×35 mm	
Installation	Rackmount	Rackmount/ Desktop	Desktop/ Wall-Mounting	Desktop/ Wall-Mounting	Desktop/ Wall-Mounting	Rackmount	Desktop/ Wall-Mounting	Desktop/ Wall-Mounting	Desktop/ Wall-Mounting	Desktop/ Wall-Mounting	
Performance	Concurrent Sessions	2,300,000	TBD	500,000	150,000	150,000	TBD	24,980	150,000	TBD	150,000
	NAT (Static IP) Download Throughput	9449 Mbps	TBD	2364 Mbps	940.5 Mbps	945.77 Mbps	TBD	942.1 Mbps	936.1 Mbps	TBD	940.1Mbps
	IPSec VPN Throughput (ESP-SHA1-AES256)	3099.4 Mbps	TBD	673.3 Mbps	617.1 Mbps	259.78 Mbps	TBD	168.5 Mbps	646.9 Mbps	TBD	652.2Mbps
	WAN Connection Type	Static/Dynamic IP, PPPoE, PPTP, L2TP, 6to4 Tunnel, Pass-Through, Mobile Broadband: 4G/3G modem for backup via USB port**									
IPSec VPN	IPSec VPN Tunnel	300	TBD	100	100	20	TBD	20	100	3	100
	Authentication & Encryption	DES, 3DES, SHA1, SHA256, SHA384, SHA512, AES128, AES192, AES256 Encryption Algorithm; IKE v1/v2									
	IPSec NAT Traversal (NAT-T)	√	√	√	√	√	√	√	√	√	√
PPTP VPN	PPTP VPN Tunnels	300 (Shared with L2TP)	TBD	60 (Shared with L2TP)	50	16	TBD	16	50	3	50
	PPTP VPN Server	√	√	√	√	√	√	√	√	√	√
	PPTP VPN Client	√	√	√	√	√	√	√	√	√	√
L2TP VPN	L2TP VPN Tunnels	300 (Shared with PPTP)	TBD	60 (Shared with L2TP)	50	16	TBD	16	50	3	50
	L2TP VPN Server	√	√	√	√	√	√	√	√	√	√
	L2TP VPN Client	√	√	√	√	√	√	√	√	√	√
OpenVPN	OpenVPN Tunnels***	110	TBD	66	55	16	TBD	16	55	18	55
Other VPN†	WireGuard, SSL, GRE	WireGuard, SSL, GRE	WireGuard, SSL, GRE	WireGuard, SSL, GRE	WireGuard, GRE	TBD	-	WireGuard, SSL, GRE	-	WireGuard, SSL, GRE	
Security	Access Control List, URL/Keyword Filter, DoS Defense, ARP Inspection, MAC Filter										
Load Balance	Multi-WAN Load Balance, Application Optimized Routing, Line Backup, Online Detection, Smart Load Balance										
NAT	One-to-One NAT, Multiple-nets NAT, Virtual Server, Port Triggering, ALG										
Routing	Static Routing, Policy Routing										
System Management	Centralized Cloud Management via Web UI or Omada App, SNMP v1/v2c/v3, Web Interface, Standalone Management										

\*These products are being developed, and the product images and specifications may vary then.











\*\*ER7212PC doesn't support 4G/3G modem mobile broadband for backup via USB port

\*\*\*These features require the use of Omada Hardware Controller, Software Controller, or Cloud-Based Controller

†GRE VPN is supported under standalone mode.

‡LTE Backup requires the use of USB dongle.







# Omada PoE Adapters







	PoE Injectors					PoE Splitter	PoE Extender	Passive PoE Adapters		
	10GE	2.5GE	GE			GE	FE	GE		
Product Picture										
Model	POE380S	POE260S	POE170S	POE160S	POE150S	POE10R	POE10E	POE4824G	POE4818G	POE2412G
Product Description	10G PoE++ Injector	2.5G PoE+ Injector	PoE++ Injector	PoE+ Injector	PoE Injector	PoE Splitter	Fast Ethernet PoE+ Extender	48V 24W Passive PoE Adapter	48V 18W Passive PoE Adapter	24V 12W Passive PoE Adapter
PoE Standard	802.3af/at/ bt type3/bt type4	802.3af/at	802.3af/at/bt type 3	802.3af/at	802.3af	802.3af	802.3af/at	Passive PoE		
RJ45 Ports	• 1× 10GE RJ45 LAN • 1× 10GE RJ45 PoE	• 1× 2.5GE RJ45 LAN • 1× 2.5GE RJ45 PoE	• 1× Gigabit RJ45 LAN • 1× Gigabit RJ45 PoE	• 1× Gigabit RJ45 LAN • 1× Gigabit RJ45 PoE	• 1× Gigabit RJ45 LAN • 1× Gigabit RJ45 PoE	• 1× Gigabit RJ45 LAN • 1× Gigabit RJ45 PoE	2× FE RJ45 PoE (1× PoE in, 1× PoE out)	• 1× Gigabit RJ45 LAN • 1× Gigabit RJ45 PoE		
Input Power	100–240 VAC	100–240 VAC	100–240 VAC	100–240 VAC	48 VDC/ 0.5 A	Max. 15.4 W (AutoDetermination)	802.3af/at	100–240 VAC	100–240 VAC	100–240 VAC
Output Power	Max. 90 W (AutoDetermination)	Max. 30 W (AutoDetermination)	Max. 60 W (AutoDetermination)	Max. 30 W (AutoDetermination)	Max. 15.4 W (AutoDetermination)	5/9/12 VDC	Max. 20 W (AutoDetermination)	48 V 0.5 A	48 V 0.375 A	24 V 0.5 A
Plug and Play	✓	✓	✓	✓	✓	✓	✓	✓	✓	✓
Dimensions (W×D×H)	155×70×42 mm	125×59.4×36.8 mm	155×70×42 mm	125×59.4×36.8 mm	80.8×54×24 mm	80.8×54×24 mm	71×26×16.2 mm	110×57×38.8 mm	85.8×43.9×35 mm	85.8×43.9×35 mm
Installation	Desktop / Wall-Mounting	Desktop / Wall-Mounting	Desktop / Wall-Mounting	Desktop / Wall-Mounting	Desktop	Desktop	Desktop	Desktop / Wall-Mounting	Desktop / Wall-Mounting	Desktop / Wall-Mounting
Operating Temperature	0–45 °C (32–113 °C)	0–40 °C (32–104 °C)	0–45 °C (32–113 °C)	0–40 °C (32–104 °C)			0–45 °C (32–113 °C)	0–40 °C (32–104 °C)		
Environment	Storage Temperature: -40°C to 70°C (-40°F to 158°F) Operating Humidity: 10% to 90%RH non-condensing; Storage Humidity: 5% to 90%RH non-condensing									



# Omada Reverse PoE Switches

Gigabit Reverse PoE Switches	
Product Picture	
Model	RP108GE
Port	7 Gigabit Passive PoE-in RJ45 Ports Voltage: 24/48 V (mixture is not supported) 1 Gigabit Passive PoE-out RJ45 Port Voltage: depending on the input voltage of PoE-in ports 1 DC Output Port Voltage: 5/12 V
Power pin of Ethernet cable	4/5+ 7/8-
PoE Supply	Passive PoE
Dimensions	6.2 × 3.9 × 1.0 in (158 × 99.1 × 25 mm)
Installation	Desktop/Wall-Mounting
Switching Capacity	16 Gbps
Features	VLAN IGMP Snooping QoS Manageable via web browser or Utility



# Omada Media Converters

Omada 100 Mbps Media Converters							
Product Picture							
Model	MC100CM	MC110CS	MC111CS	MC112CS	FC111A-20	FC111B-20	FC111PB-20
Power Input	9 VDC / 0.6A				5 VDC / 0.6 A		48 VDC / 0.5A
Fiber Ports	2× 100 Mbps SC Fiber Ports		1× 100 Mbps SC Fiber Port		1× 100 Mbps SC Fiber Port		
Copper Ports	1× 100 Mbps RJ45 Port				1× 100 Mbps RJ45 Port		1× 100 Mbps RJ45 PoE Port
Transmission Distance	2 km	20 km			20 km		
Fiber Type	Multi-mode	Single-mode			Single-mode		
Fiber Number	Dual Fibers		Single Fiber		Single Fiber		
Wave Length	1310 nm		TX: 1550 nm RX: 1310 nm	TX: 1310 nm RX: 1550 nm	TX: 1550 nm RX: 1310 nm	TX: 1310 nm RX: 1550 nm	TX: 1310 nm RX: 1550 nm
Dimensions (W × D × H)	3.7×2.9×1.1 in (94.5×73.0×27.0 mm)						
Operating Temperature	0–40 °C (32–104 °C)				0–50 °C (32–122 °C)		
Environment	Storage Temperature: -40–70 °C (-40–158 °F) Operating Humidity: 10–90% RH Non-Condensing; Storage Humidity: 5–90% RH Non-Condensing						











Omada Gigabit Media Converters							
Product Picture							
Model	MC200CM	MC210CS	MC220L	FC311A-2	FC311B-2	FC311A-20	FC311B-20
Power Input	9V/0.6A				5V/0.6A		
Fiber Ports	2 × 1000 Mbps SC Fiber Ports		1 × Gigabit SFP Port		1× 1000 Mbps SC Fiber Port		
Copper Ports	1× 10/100/1000 Mbps RJ45 Port (Auto MDI/MDIX)				1× 10/100/1000 Mbps RJ45 Port (Auto MDI/MDIX)		
Transmission Distance	550 m	20 km	Depends on the used SFP module	2 km		20 km	
Fiber Type	Multi-Mode	Single-Mode		Single-Mode			
Fiber Number	Dual Fibers			Single Fiber			
Wave Length	850 nm	1310 nm		TX: 1550 nm RX: 1310 nm	TX: 1310 nm RX: 1550 nm	TX: 1550 nm RX: 1310 nm	TX: 1310 nm RX: 1550 nm
Dimensions (W × D × H)	3.7×2.9×1.1 in (94.5×73.0×27.0 mm)						
Operating Temperature	0–40 °C (32–104 °C)				0–50 °C (32–122 °F)		
Environment	Storage Temperature: -40–70 °C (-40–158 °F) Operating Humidity: 10–90% RH Non-Condensing; Storage Humidity: 5–90% RH Non-Condensing						

Omada Power Chassis	
Product Picture	 
Model	MC1400 <span style="margin-left: 300px;">FC1420</span>
Power Input	<ul style="list-style-type: none"> <li>• Up to 14 Media Converter Units</li> <li>• 9 VDC / 0.6 A Power Output</li> <li>• Redundant Power Supply                             <ul style="list-style-type: none"> <li>• Hot-Swappable</li> </ul> </li> </ul> <span style="margin-left: 300px;"> <ul style="list-style-type: none"> <li>• Up to 14 Media Converter Units</li> <li>• 5 VDC / 0.6 A Power Output</li> <li>• Redundant Power Supply                             <ul style="list-style-type: none"> <li>• Hot-Swappable</li> </ul> </li> </ul> </span>



# Omada Rackmount Kit

Omada Rackmount Kit	
Product Picture	 
Model	RackMount Kit-19 <span style="margin-left: 300px;">RackMount Kit-13</span>
Power Input	<ul style="list-style-type: none"> <li>• Compatible with Omada 19-inch rack mount switches and other products.                             <ul style="list-style-type: none"> <li>• Reliable metal materials</li> </ul> </li> </ul> <span style="margin-left: 300px;"> <ul style="list-style-type: none"> <li>• Compatible with Omada 13-inch rack mount switches and other products.                             <ul style="list-style-type: none"> <li>• Reliable metal materials</li> </ul> </li> </ul> </span>



# Omada SFP/SFP+ Modules

	10G SFP+ Modules		Gigabit SFP Modules						SFP/SFP+ RJ45 Modules	
Product Picture										
Model	SM5110-LR	SM5110-SR	SM311LS	SM311LM	SM321A	SM321B	SM321A-2	SM321B-2	SM5310-T	SM311T
Data Rate	10 Gbps		1.25 Gbps						10.31 Gbps	1.25 Gbps
Fiber Ports	2× LC/UPC Duplex Ports		2× LC/UPC Duplex Ports		1× LC/UPC Duplex Port				-	-
RJ45 Ports	-								1× 10 Gbps RJ45 Ports	1× 1000 Mbps RJ45 Ports
Transmission Distance	10 km	300 m	20 km	550 m	20 km		2 km		30 m	100 m
Transmission Media	Dual Single-Mode Fibers	Dual Multi-Mode Fibers	Dual Single-Mode Fibers	Dual Multi-Mode Fibers	Single Single-Mode Fiber				Cat6a or above Ethernet Cable	Cat5e or above Ethernet Cable
Wave Length	1310nm	850nm	1310 nm	850 nm	TX: 1550 nm RX: 1310 nm	TX: 1310 nm RX: 1550 nm	TX: 1550 nm RX: 1310 nm	TX: 1310 nm RX: 1550 nm	-	-
Operating Temperature	0-70 °C (32-158 °C)									
Environment	Storage Temperature: -40°C to 70°C (-40°F to 158°F) Operating Humidity: 10% - 90% RH non-condensing; Storage Humidity: 5% - 90% RH non-condensing									

# Omada 10G SFP+ Direct Attach Cable

	Omada 10G SFP+ Direct Attach Cable	
Product Picture		
Model	SM5220-3M	SM5220-1M
Length	3 m	1 m
Connector Type	10G SFP+ connector on both sides	
Cable Type	Passive Twinax	
Data Rate	10 Gbps	
Environment	Operating Temperature: 0-70 °C (32-158 °F); Storage Temperature: -40-80 °C (-40-176 °F); Operating Humidity: 10-90% RH Non-Condensing; Storage Humidity: 5-90% RH Non-Condensing	

# Omada Power Supply Modules

	Omada Power Supply Modules		
Product Picture			
Model	PSM500-AC	PSM900-AC	PSM550-AC
Power Input	100 V-240 V~ 50/60 Hz 8A	100-120V ~ 50/60Hz 12A or 121- 240V~ 50/60Hz 10A (vary from locations)	100 V-240 V~ 50/60 Hz 7A
Output Voltage	53.5 VDC	53.5 VDC	12 VDC
Max. Output Current	9.35 A	16.5 A	45 A
Max. Output Power	500 W	900 W	550 W
Suitable model	SG6654XHP & SG6428XHP		SX6632YF
Fan	√	√	√
Dimensions	259.5×95.8×40.1 mm		225.0×73.5×40.0 mm
Operating Temperature	0-45 °C (32-113 °F)		
Environment	Storage Temperature: -40-70 °C (-40-158 °F) Operating Humidity: 10%-90% RH non-condensing; Storage Humidity: 5%-90% RH non-condensing		





**TP-LINK CORPORATION PTE. LTD.**

E-mail: [info@tp-link.com](mailto:info@tp-link.com)  
Homepage: [www.tp-link.com](http://www.tp-link.com)

Note: Some products and functions may be in development and may vary from images and features.

Specifications are subject to change without notice. TP-Link is a registered trademark of TP-LINK CORPORATION PTE. LTD. Other brands and product names are trademarks or registered trademarks of their respective holders. Copyright © 2024 TP-LINK CORPORATION PTE. LTD. All rights reserved. PN: 8392501199